

# FURUNO

## OPERATOR'S MANUAL

COLOR LCD SOUNDER

---

MODEL FCV-1200L/1200LM

---



**FURUNO ELECTRIC CO., LTD.**  
NISHINOMIYA, JAPAN



(Elemental Chlorine Free)

The paper used in this manual  
is elemental chlorine free.

© **FURUNO ELECTRIC CO., LTD.**

9-52 Ashihara-cho,  
Nishinomiya 662-8580, JAPAN

Telephone : 0798-65-2111

Fax : 0798-65-4200

FURUNO Authorized Distributor/Dealer

All rights reserved.

Printed in Japan

FIRST EDITION : APR. 2000

R : FEB. 21, 2007

Pub. No. OME-23650

( DAMI ) FCV-1200L/LM



\*00080900514\*



# SAFETY INSTRUCTIONS



## WARNING



**ELECTRICAL SHOCK HAZARD**  
**Do not open the equipment.**

Only qualified personnel should work inside the equipment.

**Immediately turn off the power at the switchboard if water leaks into the equipment or something is dropped in the equipment.**

Continued use of the equipment can cause fire or electrical shock. Contact a FURUNO agent for service.

**Do not disassemble or modify the equipment.**

Fire, electrical shock or serious injury can result.

**Immediately turn off the power at the switchboard if the equipment is emitting smoke or fire.**

Continued use of the equipment can cause fire or electrical shock. Contact a FURUNO agent for service.

**Make sure no rain or water splash leaks into the equipment.**

Fire or electrical shock can result if water leaks in the equipment.



## WARNING

**Keep heater away from equipment.**

A heater can melt the equipment's power cord, which can cause fire or electrical shock.

**Use the proper fuse.**

Fuse rating is shown on the equipment. Use of a wrong fuse can result in equipment damage.



## CAUTION

**A warning label is attached to the equipment. Do not remove the label. If the label is missing or illegible, contact a FURUNO agent or dealer.**

### WARNING

To avoid electrical shock, do not remove cover. No user-serviceable parts inside.

(Processor unit)  
Name: Warning Label (1)  
Type: 86-003-1011-1  
Code No.: 100-236-231

(Monitor unit)  
Name: Warning Label (2)  
Type: 03-129-1001-1  
Code No.: 100-236-741

### DANGER

Electrical shock hazard. Power off control unit and unplug CN2 before servicing.

(Processor unit)  
Name: Power Warning Label  
Type: 02-127-2002-0  
Code No.: 100-283-240

## About the TFT LCD

The TFT LCD is constructed using the latest LCD techniques, and displays 99.99% of its pixels. The remaining 0.01% of the pixels may drop out or blink, however this is not an indication of malfunction.

# FOREWORD

---

## A Word to FCV-1200L/1200LM Owners

Congratulations on your choice of the FURUNO FCV-1200L/FCV-1200LM COLOR LCD SOUNDER. We are confident you will see why the FURUNO name has become synonymous with quality and reliability.

FCV-1200L is a dual-frequency color LCD sounder, and FCV-1200LM is a monitor which displays the signal from an external video sounder.

For over 50 years FURUNO Electric Company has enjoyed an enviable reputation for innovative and dependable marine electronics equipment. This dedication to excellence is furthered by our extensive global network of agents and dealers.

This equipment is designed and constructed to meet the rigorous demands of the marine environment. However, no machine can perform its intended function unless installed, operated and maintained properly. Please carefully read and follow the recommended procedures for operation and maintenance.

We would appreciate hearing from you, the end-user, about whether we are achieving our purposes.

Thank you for considering and purchasing FURUNO equipment.

## Features

- 8- or 16- color presentation (including background) provides detailed information on fish density and bottom composition, on a 10.4 inch color LCD.
- Furuno Free Synthesizer (FFS) transceiver design allows use of user-selectable operating frequencies.
- You can select display orientation; Portrait (vertical) or Landscape (horizontal).
- Automatic bottom tracking features permits unattended operation.
- Frequency mixing picture helps discriminate fish species.
- Alarms: Fish, Bottom, Fish-Bottom, Water Temperature (temperature data required).
- A-scope presentation displays echoes at each transmission with amplitudes and colors according to intensities.
- Unique split range control allows independent range settings in dual-frequency mode.

# TABLE OF CONTENTS

---

<b>FOREWORD .....</b>	<b>ii</b>
<b>CONTENTS BY INDICATIONS .....</b>	<b>v</b>
<b>SYSTEM CONFIGURATION .....</b>	<b>vi</b>
<b>1. BASIC OPERATION.....</b>	<b>1-1</b>
1.1 Key/Control Operation.....	1-1
1.2 Turning the Power On/Off.....	1-3
1.3 Adjusting the Brilliance of LCD and Key Panel.....	1-3
1.4 Presentation Mode .....	1-4
1.5 Selecting Basic Range .....	1-11
1.6 Shifting the Basic Range .....	1-12
1.7 Adjusting Gain.....	1-13
1.8 Measuring Depth.....	1-13
1.9 Marker Line.....	1-14
1.10 Adjusting Clutter.....	1-15
1.11 Adjusting TVG.....	1-16
1.12 Eliminating Weak Echoes.....	1-18
1.13 Picture Advance Speed .....	1-19
1.14 A-Scope Display .....	1-21
1.15 Suppressing Interference .....	1-22
1.16 Adjusting the External Video Sounder Picture.....	1-24
<b>2. MENU OPERATION .....</b>	<b>2-1</b>
2.1 Basic Menu Operation.....	2-1
2.2 DISP Menu .....	2-3
2.3 ALM Menu .....	2-7
2.4 TX/RX Menu .....	2-10
2.5 USER-1/2 Menu.....	2-12

<b>3. SYSTEM MENU.....</b>	<b>3-1</b>
3.1 SYSTEM Menu Operation.....	3-1
3.2 SYSTEM SETTING Menu.....	3-2
3.3 ES/DRAFT SETTING Menu.....	3-4
3.4 RANGE SETTING Menu.....	3-7
3.5 TEMP SETTING Menu.....	3-9
3.6 NET SONDE SETTING Menu.....	3-10
3.7 USER COLOR SETTING Menu.....	3-13
3.8 USER CLUTTER SETTING Menu.....	3-15
3.9 NAV DATA SETTING Menu.....	3-16
3.10 TARGET ECHO SETTING Menu.....	3-17
3.11 STABILIZATION Menu.....	3-18
<b>4. INTERPRETING THE DISPLAY.....</b>	<b>4-1</b>
4.1 Color Bar.....	4-1
4.2 Zero Line.....	4-2
4.3 Bottom Echoes.....	4-2
4.4 Fish Schools.....	4-3
4.5 Other Echoes.....	4-4
<b>5. MAINTENANCE &amp; TROUBLESHOOTING.....</b>	<b>5-1</b>
5.1 Maintenance.....	5-1
5.2 Fuse Replacement.....	5-2
5.3 Troubleshooting.....	5-3
5.4 Diagnostic Test.....	5-4
5.5 Test Pattern.....	5-6
5.6 Default Setting.....	5-7
<b>APPENDIX 1 MENU TREE.....</b>	<b>AP-1</b>
<b>APPENDIX 2 SCREEN DIVISION.....</b>	<b>AP-6</b>
<b>APPENDIX 3 DISPLAY DIVISION.....</b>	<b>AP-9</b>
<b>SPECIFICATIONS.....</b>	<b>SP-1</b>
<b>INDEX.....</b>	<b>IN-1</b>

# CONTENTS BY INDICATIONS

The illustration below shows the indications as they appear on the portrait-type monitor unit. Their locations are also the same on the landscape-type monitor unit. This manual shows all display screen illustrations using the portrait-type monitor unit. The numbers in parentheses are page numbers.

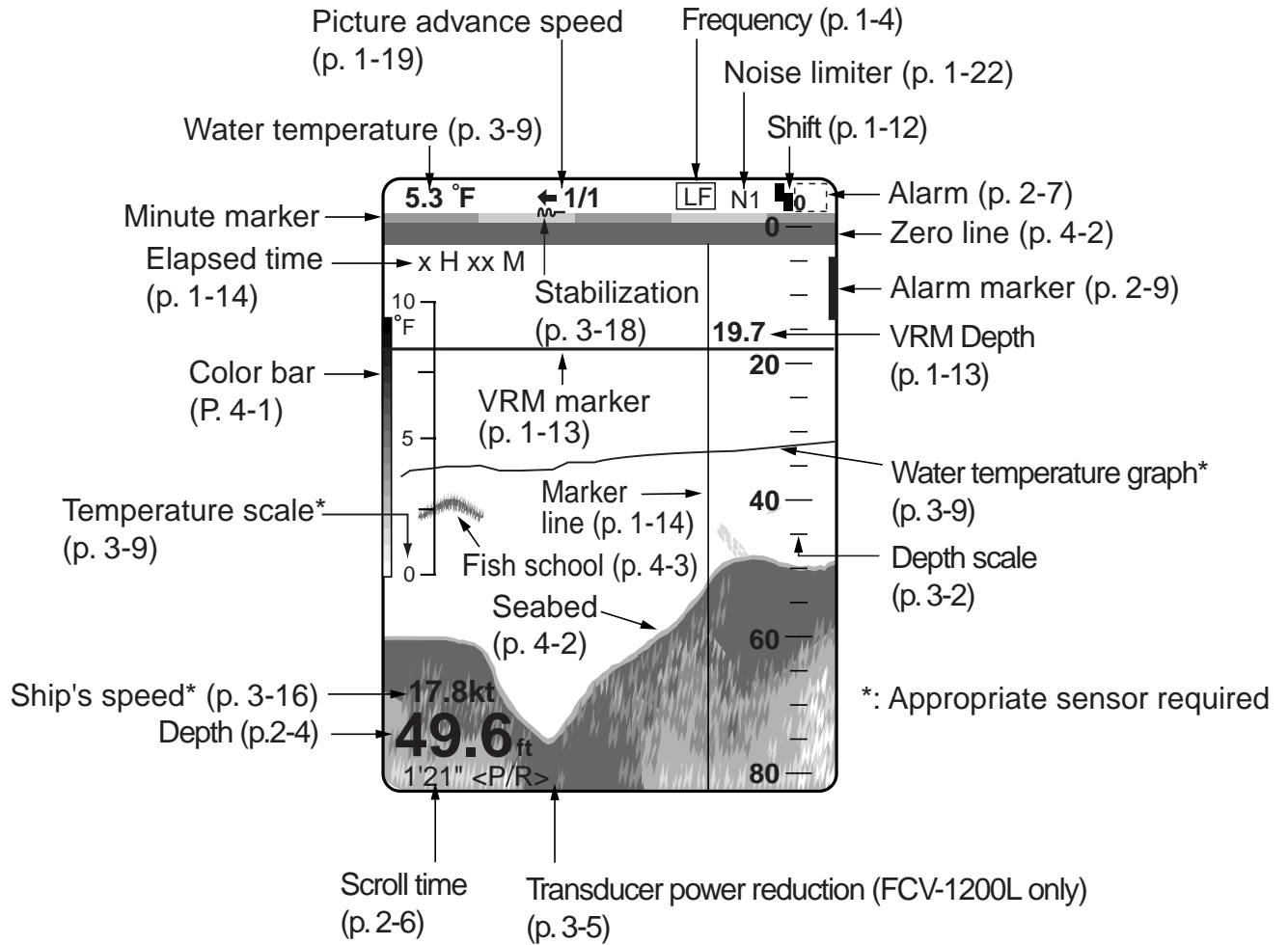

# SYSTEM CONFIGURATION

**Note:** This equipment is intended for marine use only.

## Standard type

Monitor unit MU-101C is supplied as standard. The illustration below shows the portrait-type monitor unit and control unit.

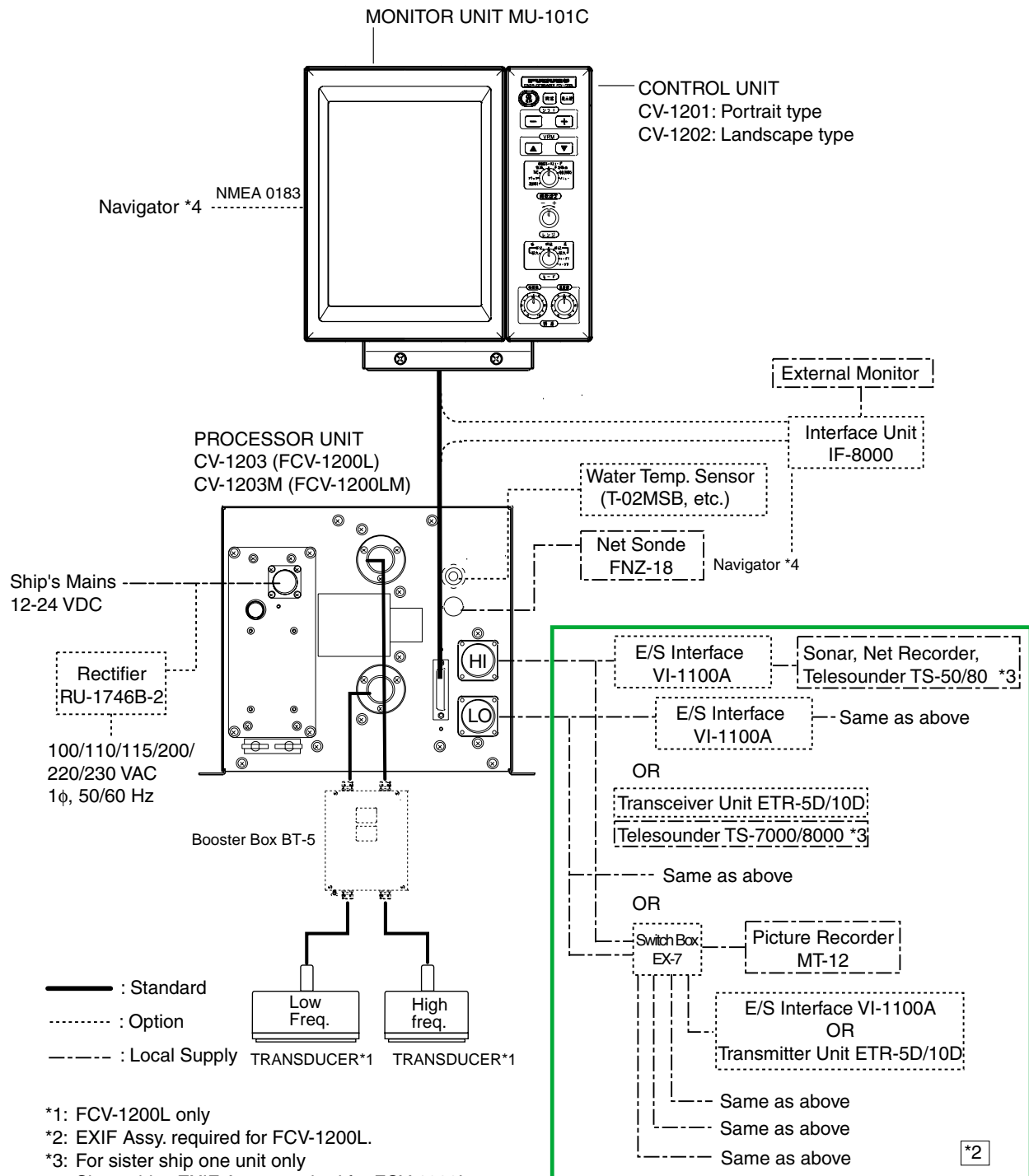



## Blackbox type

Monitor unit MU-101C is not supplied. The external monitor is required. Connect the control unit CV-1201 or CV-1202 to the interface unit IF-8000.

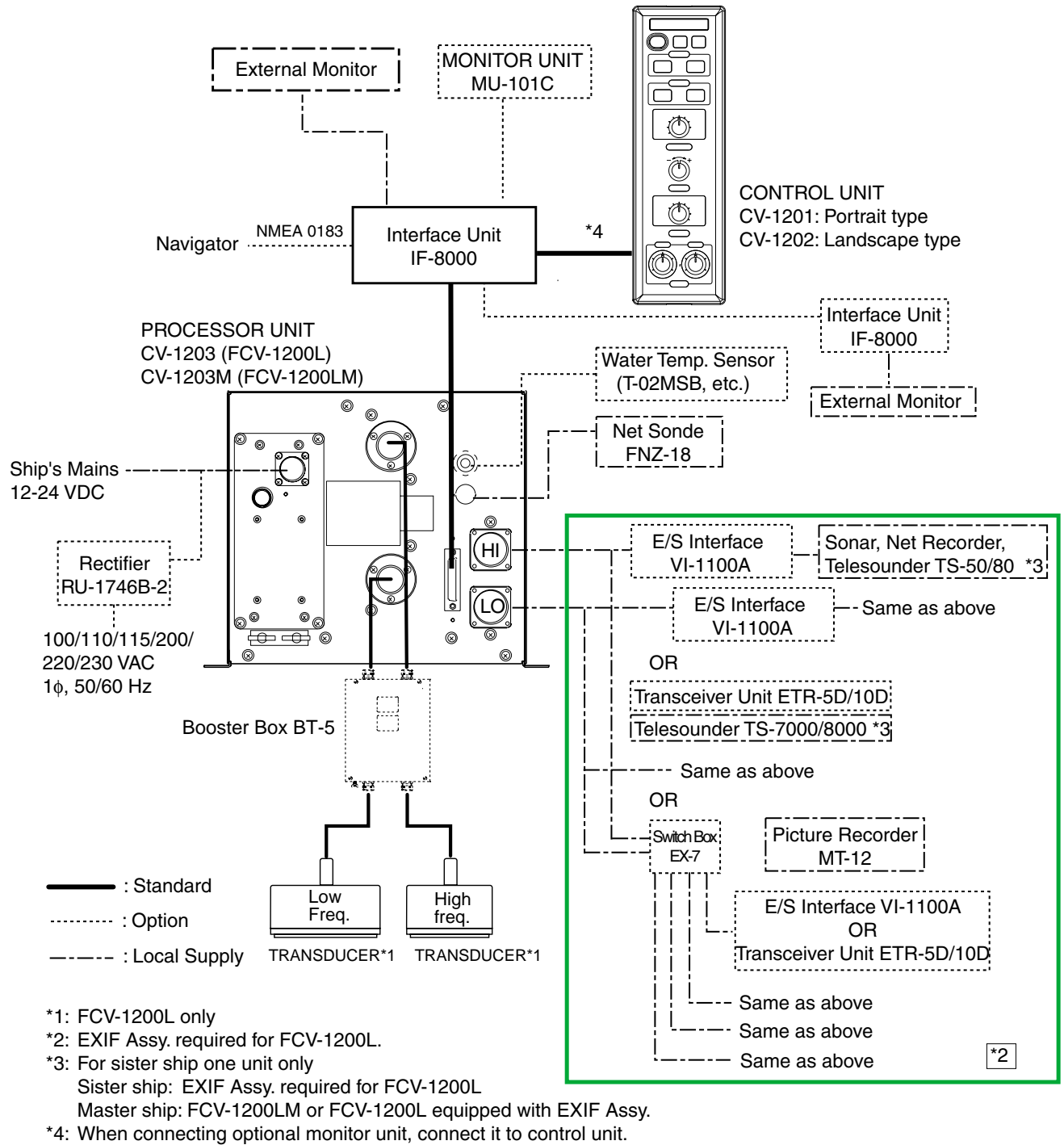

### How to remove the hard cover

Place your thumbs at the locations shown with circles in the illustration at right, and then lift the cover while pressing it with your thumbs.

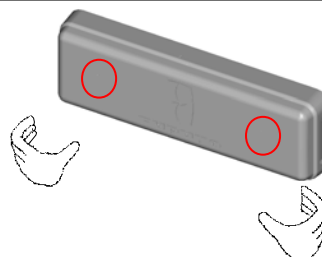

This page is intentionally left blank.

# 1. BASIC OPERATION

## 1.1 Key/Control Operation

### 1.1.1 Portrait-type control unit

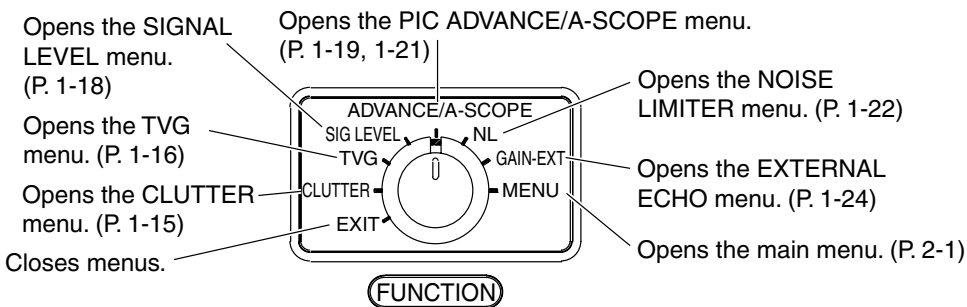
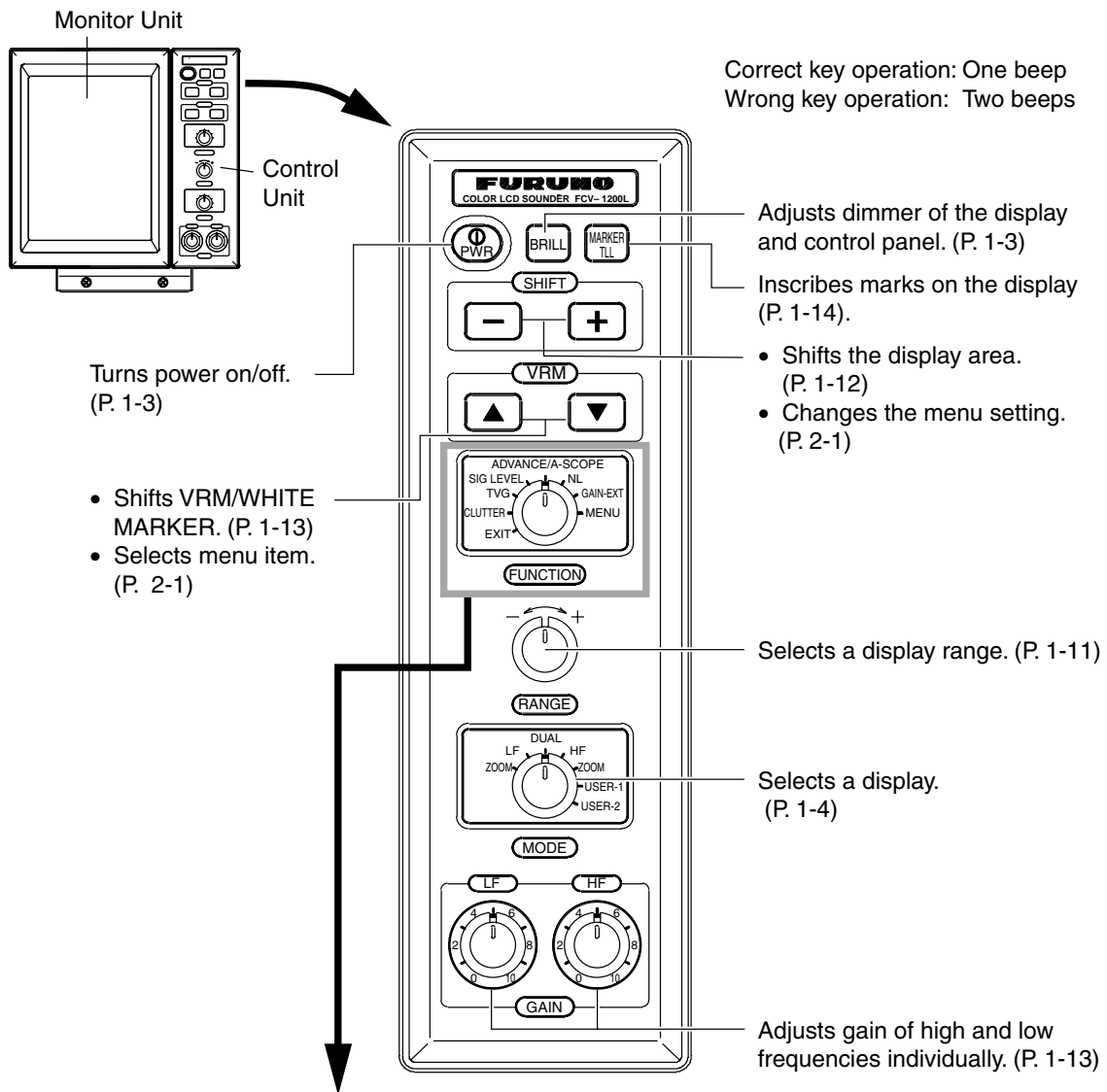

Control unit (Portrait type)

## 1.1.2 Landscape-type control unit

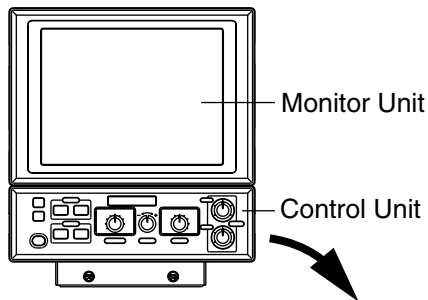

Correct key operation: One beep  
Wrong key operations: Two beeps

Adjusts dimmer of the display and control panel (P. 1-13).

- Shifts the display area. (P. 1-12)
- Changes menu setting. (P. 2-1)

Inscribes marks on the display (P. 1-14).

Selects the display. (P.1-4)

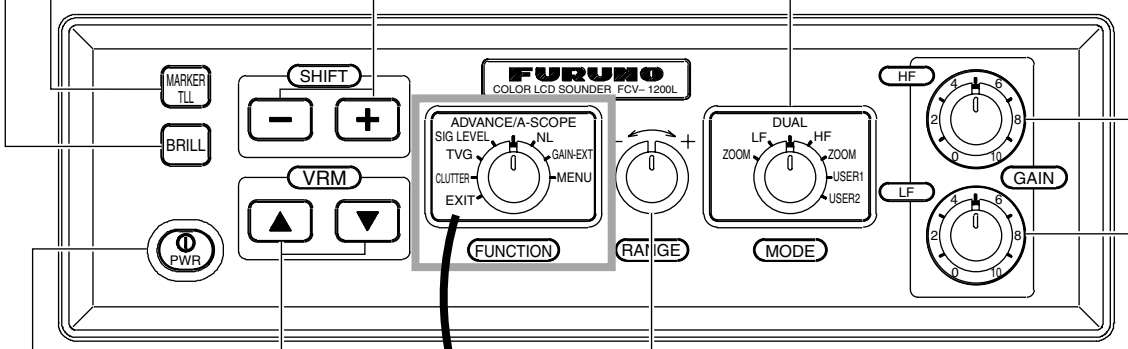

Turns power on/off. (P.1-3)

Selects the display range. (P. 1-11)

Adjusts gain of high and low frequencies individually. (P. 1-13)

- Shifts VRM/WHITE MARKER. (P. 1-13)
- Selects menu item. (P. 2-1)

Opens the SIGNAL LEVEL menu. (P. 1-18)

Opens the PIC ADVANCE/A-SCOPE menu. (P. 1-19, 1-21)

Opens the NOISE LIMITER menu. (P. 1-22)

Opens the TVG menu. (P. 1-16)

Opens the CLUTTER menu. (P. 1-15)

Opens the EXTERNAL ECHO menu. (P. 1-24)

Opens the main menu. (P. 2-1)

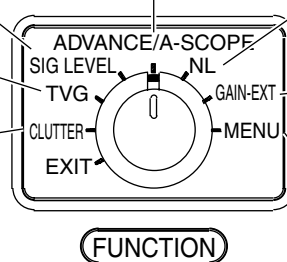

Control unit (Landscape type)

## 1.2 Turning the Power On/Off

1. Press the [PWR] key to turn the power on.  
Beep sounds, and then the power turns on. The display selected with the [MODE] switch appears.
2. Press the [PWR] key again to turn the power off.

**Note:** Wait for five seconds before turning on the power again.

## 1.3 Adjusting the Brilliance of LCD and Key Panel

The brilliance of the LCD and the dimmer of key panel may be adjusted as below. The LCD brilliance is adjustable 10 steps; the panel dimmer in 5 steps.

1. Press the [BRILL] key to open the BRILL/PANEL DIMMER window.

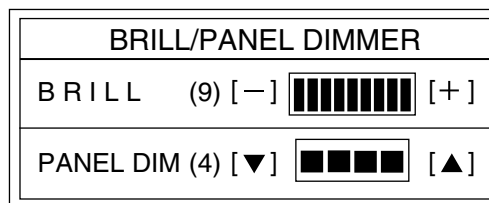

**Note:** Location of arrow keys on the brilliance setting window is opposite of same controls on the control unit.

*Brill/panel dimmer window*

2. Press the [+] or [-] key to adjust the LCD brilliance (0 – 9).  
([+] key: bright, [-] key: dark)

**Note:** Brilliance must be adjusted within five seconds after pressing the [BRILL] key or the brill/panel dimmer window will be erased.

3. Press the [▲] or [▼] key to adjust the key panel dimmer (0 – 4, 0: OFF, 4: Maximum).  
Adjust the key panel brilliance within five seconds or the window will be erased.

**Note1:** When turning off the power with brilliance set to minimum, since nothing will appear on the display the next time the power is turned on. In this case, press the [BRILL] key several times.

**Note2:** The brilliance of a commercial monitor cannot be adjusted with the [BRILL] key. Use the associated control on the monitor.

# 1.4 Presentation Mode

Seven presentation modes are available with the [MODE] switch.

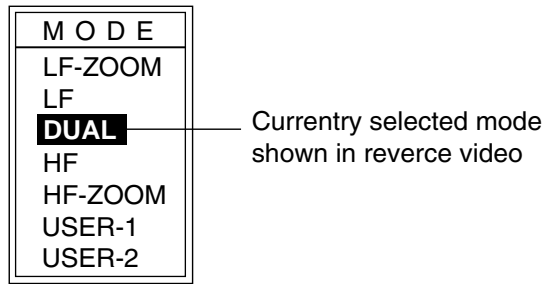

Display mode window

## Single picture (low frequency or high frequency)

### Low frequency (LF)

The lower the frequency of the ultrasonic pulse the wider the detection area. Thus, the low frequency is suitable for general search and judging bottom condition.

### High frequency (HF)

The higher the frequency of the ultrasonic pulse the better the resolution. Therefore, the high frequency pulse is useful for detailed observation of fish echoes.

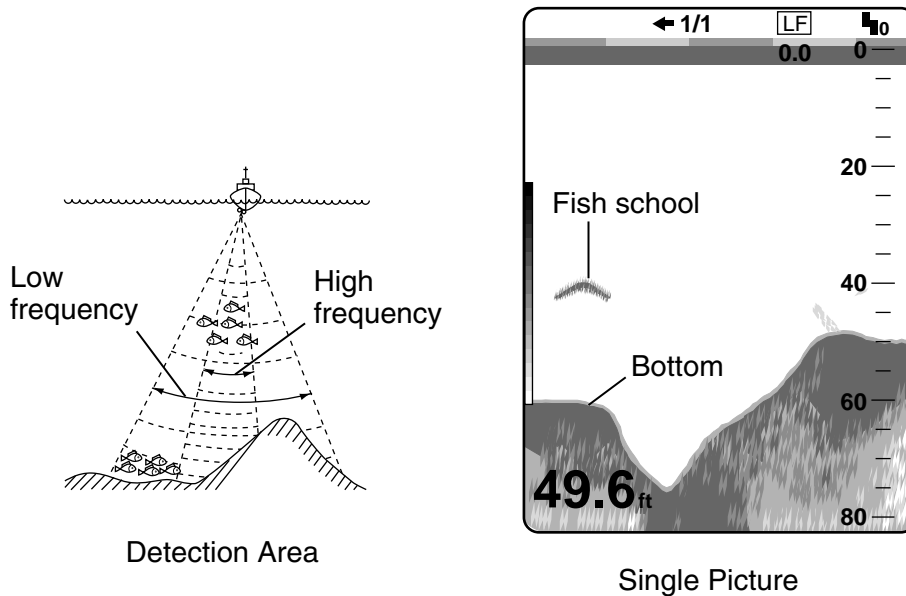

Comparison of detection ranges, sample single picture (low frequency)

# Dual

Provides the low frequency picture on the left 1/2 of the screen; the high frequency on the right 1/2.

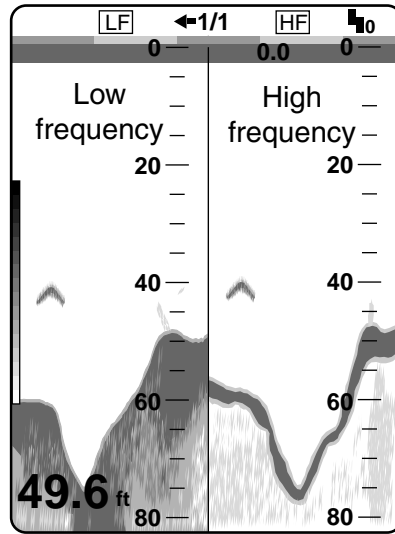

Frequency	Beamwidth	Echo trail
Low	wide	Long
High	Narrow	Short

*Dual frequency display*

# ZOOM

The “single picture” (high or low frequency) appears on the right 1/2 of the screen and the zoom picture on the left 1/2. The zoom picture may be selected among BOTTOM LOCK, BOTTOM ZOOM, MARKER ZOOM, DISCRIM (discrimination) 1/2 and DISCRIM (discrimination) 1/3. The default zoom picture is BOTTOM LOCK. You can select through the menu. See page 2-3.

## BOTTOM LOCK

The bottom lock display shows the area between the zoom marker and the bottom as a straight line to distinguish it from fish near the bottom, and thus it is useful for discriminating fish near the bottom.

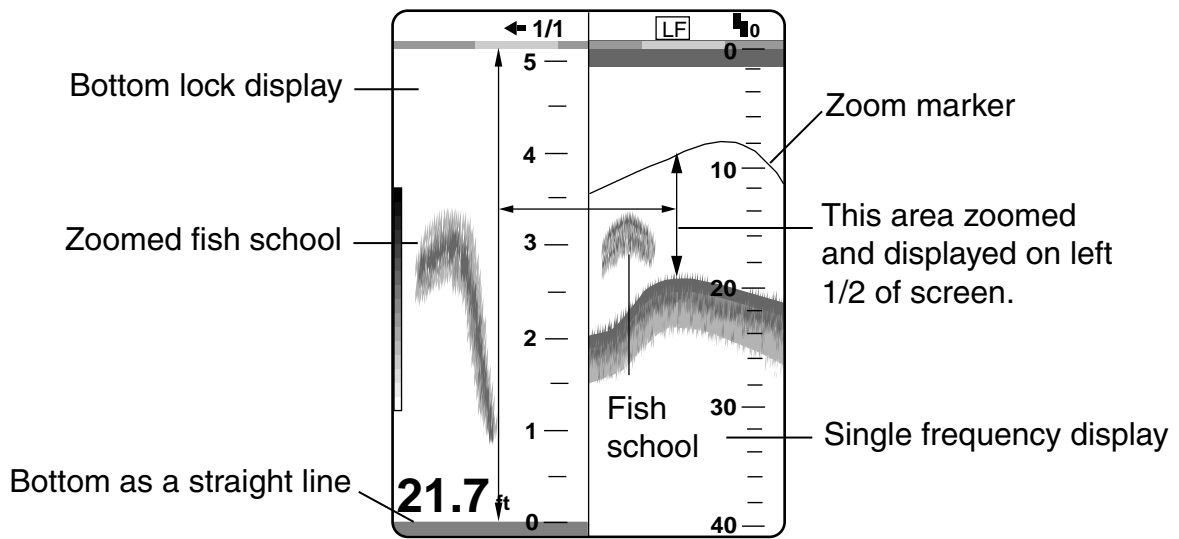

*Bottom lock display*



## **BOTTOM ZOOM**

The bottom zoom display shows the zoomed bottom (automatically tracked) on the left 1/2 of the screen. When the bottom depth increases, the display shifts to keep the bottom echo at the lower part of the screen.

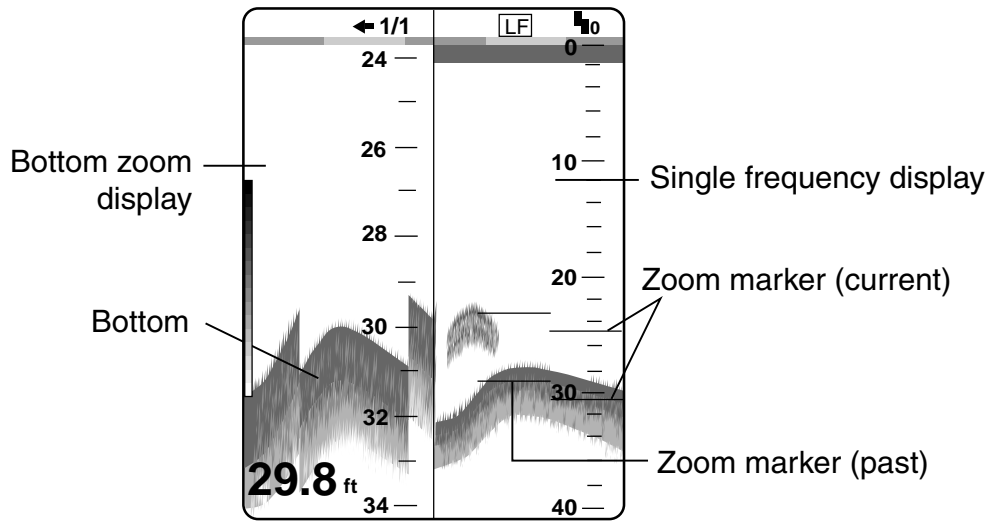

*Bottom zoom display*

## **MARKER ZOOM**

The marker zoom display expands the area selected with the VRM on the normal picture to full vertical size of the screen on the left-half window. This mode is useful for observing specific fish school.

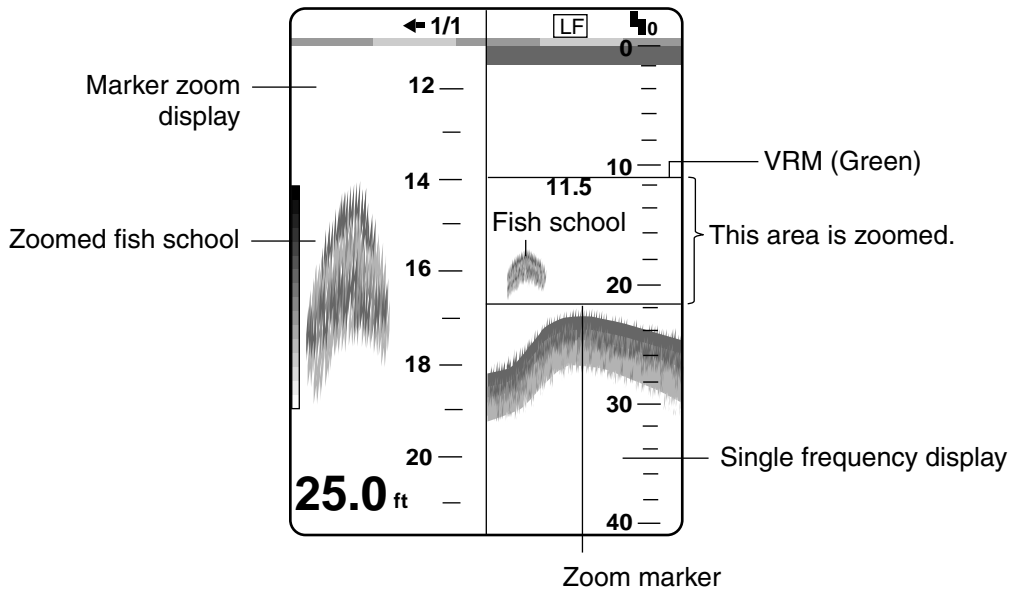

*Marker zoom display*

## DISCRIM 1/2

The discrim(ination) 1/2 screen shows the single picture on the right 1/2 of the screen and the bottom lock display and discriminator display occupy the left 1/2 of the screen. The discriminator display shows the bottom as a straight line, which is useful for determining bottom hardness.

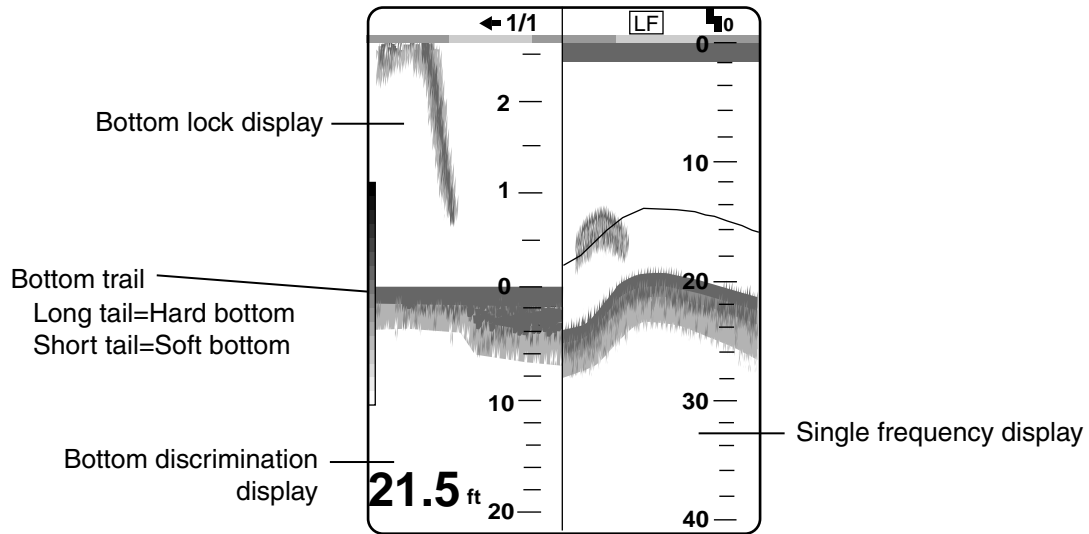

*Discrim 1/2 display*

## DISCRIM 1/3

This display is similar to the DISCRIM 1/2 display except the bottom discriminator display occupies only 1/3 of the left 1/2 of the screen as below.

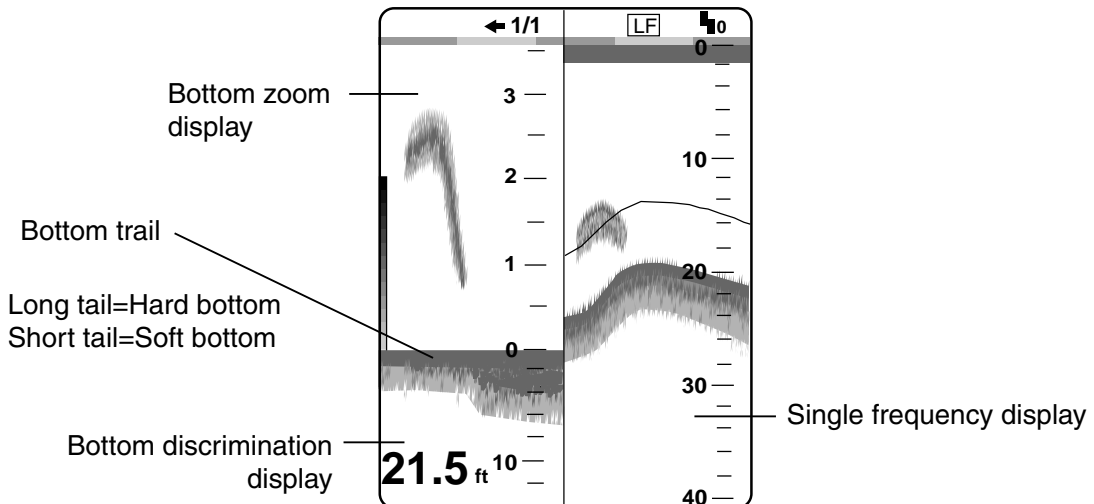

*Discrim 1/3 display*

## USER 1, 2

The display set at the user 1 (user 2) menu appears. Default setting is as follows.

USER 1: Vertical split three screens (LF + HF + MIX)

USER 2: Vertical and horizontal split four screens (LF + HF + LF bottom lock +HF bottom lock displays)

This setting may be changed through the menu. For further details see page 2-11.

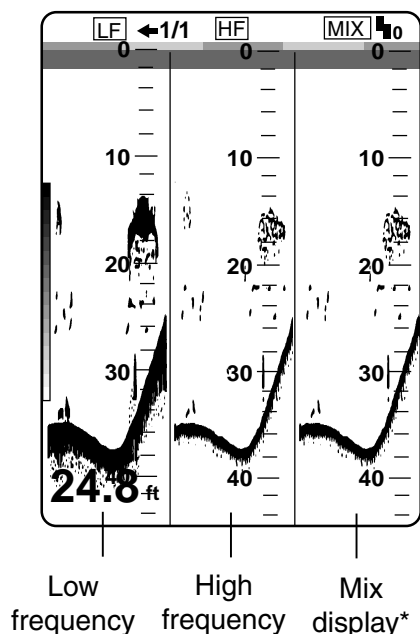

*User 1 display*

### **\*Mix**

This mode compares echo intensity between low and high frequencies, and displays echoes from tiny fish in discriminative colors. This is done by utilizing the fact that tiny fish return a stronger echo against a high frequency rather than a low frequency. This is done as below.

1. If a high frequency echo is stronger than the corresponding echo on the low frequency, the high frequency echo is displayed.
2. If the low frequency echo is stronger than or equal to the high frequency echo, it is less likely to be a tiny fish and therefore is displayed in blue.
3. If the echoes on both frequencies have the intensity corresponding to reddish brown or red, they are displayed in reddish brown or red: this is necessary to display the zero line and bottom in reddish brown or red.

In other words, the echoes displayed in orange thru light-blue may be considered to be tiny fish such as whitebait.

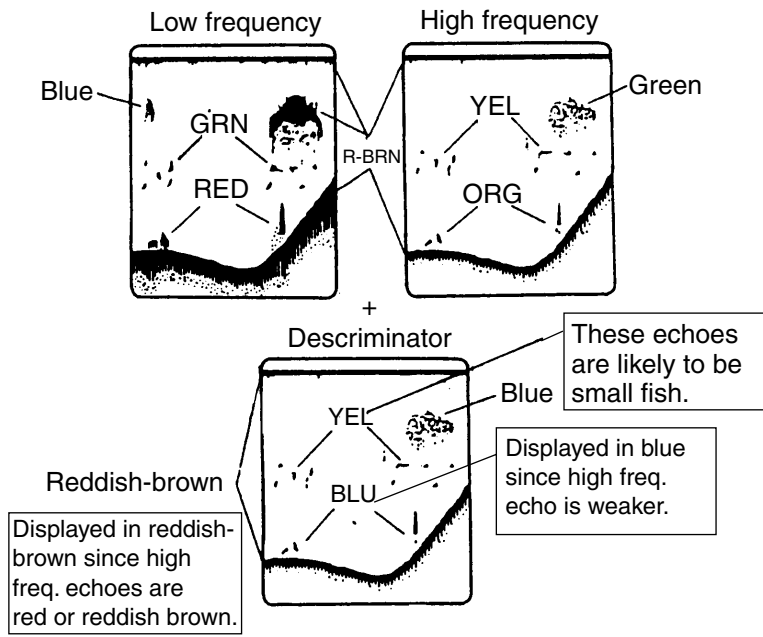

*How the mix display works*

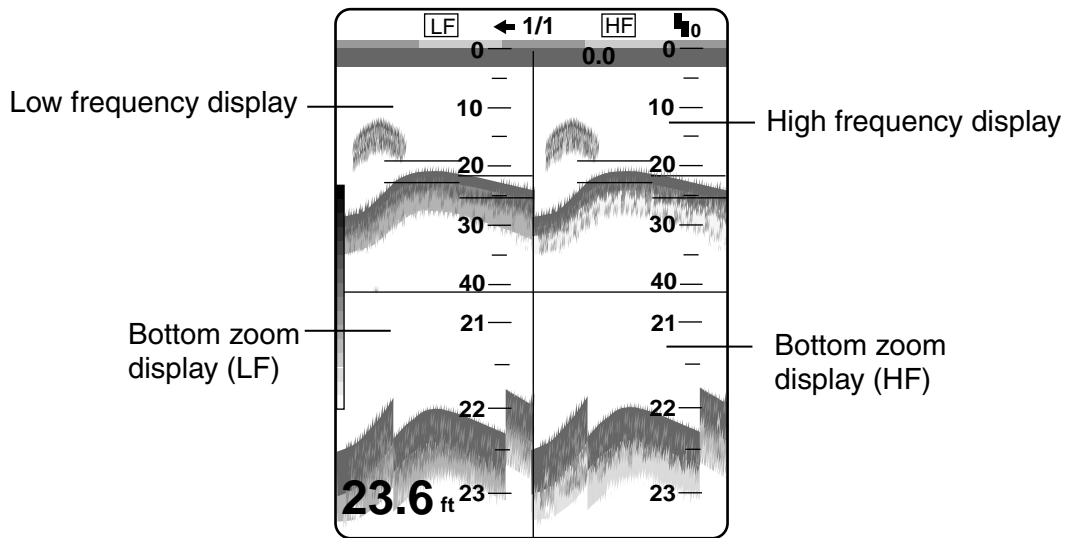

*User 2 display*

## 1.5 Selecting Basic Range

The basic range may be selected with the [RANGE] switch from the eight ranges listed below. (The default unit of depth measurement is feet.) These eight ranges may be programmed as desired. For details, see page 3-7.

RANGE
30 ft
60 ft
<b>120 ft</b>
250 ft
500 ft
1000 ft
1600 ft
3000 ft

*Range setting window (ex. feets)*

*Basic ranges (default setting)*

Range Unit	Range Switch Position							
	1	2	3	4	5	6	7	8
Feet	30	60	120	250	500	1000	1600	3000
Meter	10	20	40	80	150	300	500	1000
Fathom	5	10	20	40	80	160	250	500
Hiro (Japanese)	6	12	25	50	100	200	300	600
Passi/Braza	6	12	25	50	100	200	300	600

**Note1:** This setting must be done within five seconds after rotating the [RANGE] switch once or the range window will be erased.

**Note2:** Range for high and low frequencies can be set separately.

**Note3:** For how to select unit of depth measurement of depth, see page 3-3.

## 1.6 Shifting the Basic Range

The [-] and [+] keys determine the start depth of the picture. Start depth (shift) is shown at the top of the screen. The shift value setting is reflected on all other range by default. This function is not available when AUTO SHIFT is ON in DISP menu.

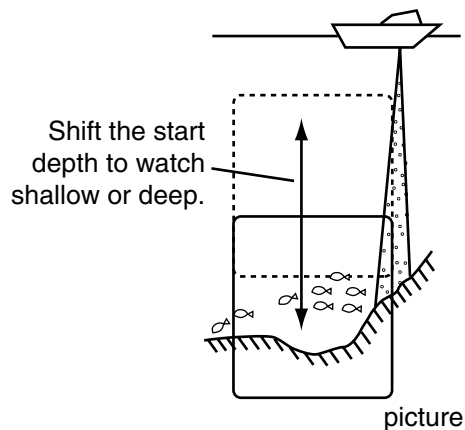

*Principle of shift*

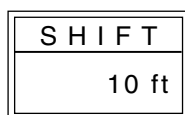

*Shift window (screen center), shift indication (top right corner)*

- Note1:** This operation must be done within five seconds after pressing the [-] or [+] key or the shift window will be erased.
- Note2:** The FCV-1200L/LM can automatically shift the display range to provide virtually hands-free automatic operation. This can be done through the menu. For further details see page 2-5.
- Note3:** You can set shift value independently for each range. See page 3-3.

## 1.7 Adjusting Gain

The [GAIN] control adjusts the sensitivity of the receiver. Adjust it so excessive noise just disappears from the screen.

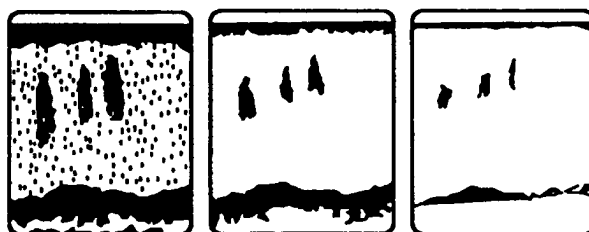

Gain too high      Gain proper      Gain too low

*Examples of proper and improper gain levels*

## 1.8 Measuring Depth

Use [▲] or [▼] key to place the VRM on the object to measure depth. Depth is digitally displayed above the VRM.

**Note:** This operation is not available when the white marker window appears (by pressing the [▲] or [▼] key). Select VRM at MARKER SELECT in DISP menu to use the VRM.

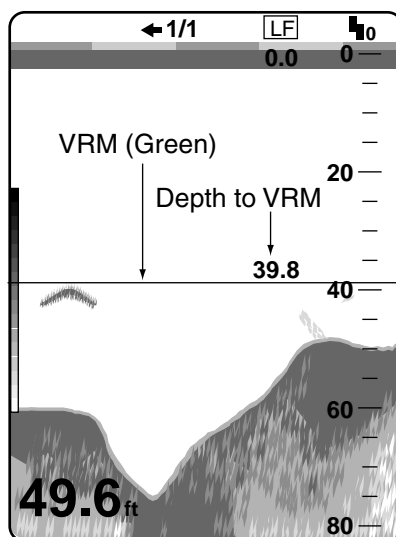

*How to use the VRM*

## 1.9 Marker Line

The [MARKER/TLL] key inscribes a vertical line when pressed. It may be used to denote a fish school or other important echo.

At the same moment the key is pressed latitude and longitude position may be output to connected navigation plotter and marked on its screen. (This feature requires a navigation plotter.) For further details see TLL OUTPUT on page 3-16.

Elapsed time from the moment that the [MARKER/TLL] key is pressed may be displayed at the upper-left corner of the screen. For details, see page 2-5.

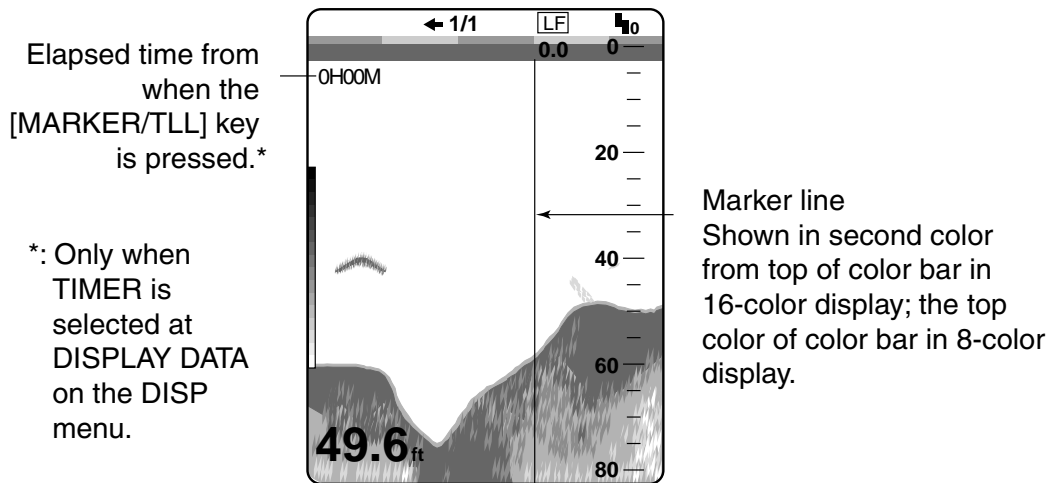

*Marker/TLL key function*



## 1.10 Adjusting Clutter

When blue dots appear over the entire screen (mainly caused by dirty water), use the clutter function to eliminate them.

1. Rotate the [FUNCTION] switch to select CLUTTER.

The clutter menu appears.

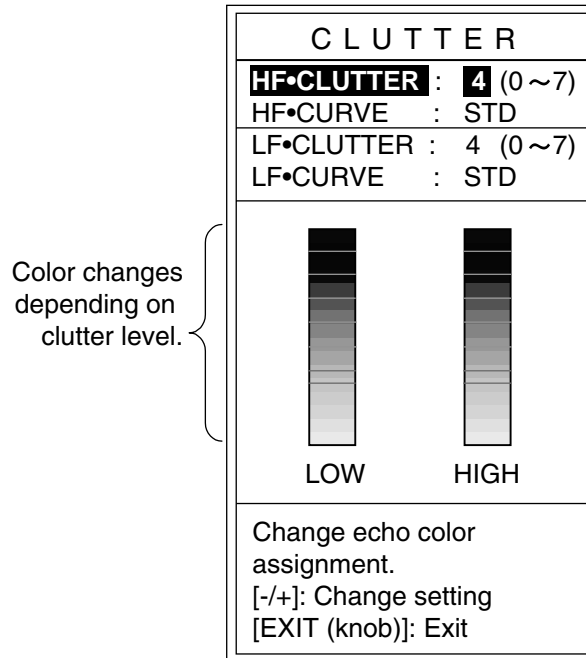

*Clutter menu*

- For dual display → Go to step 2.
  - For other modes → Go to step 3.
2. Press the [▲] or [▼] key to select HF CURVE or LF CURVE as appropriate.
  3. Press the [-] or [+] key to open the clutter curve selection window (default: STD).



*Clutter curve selection window*

STD: The higher the clutter level the smaller weak echoes are displayed. (default setting)

LINEAR: The higher the clutter level the smaller all echoes are displayed.

CUSTOM: Applies the user clutter settings to the clutter menu.

4. Press the [▲] or [▼] key to close the window.
5. Press the [▲] or [▼] to select HF CLUTTER or LF CLUTTER as appropriate.
6. Press the [-] or [+] key to set clutter rejection level. (0-7, 0 turns clutter rejector off.)

*Clutter setting window*

7. Rotate the [FUNCTION] switch fully counterclockwise to select EXIT.

**Note:** To use the user clutter setting menu setting is reflected on this function, select CUSTOM at step 3.

## 1.11 Adjusting TVG

The TVG compensates for propagation loss of sound, so that the echoes from the same size fish schools are displayed in the same color. Avoid excessive TVG; weak echoes may not be displayed. The TVG is also useful for reducing surface noise.

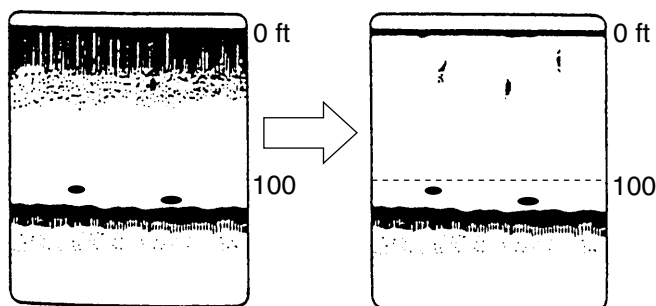

*How TVG works*

1. Rotate the [FUNCTION] switch to select TVG.

The TVG menu appears.

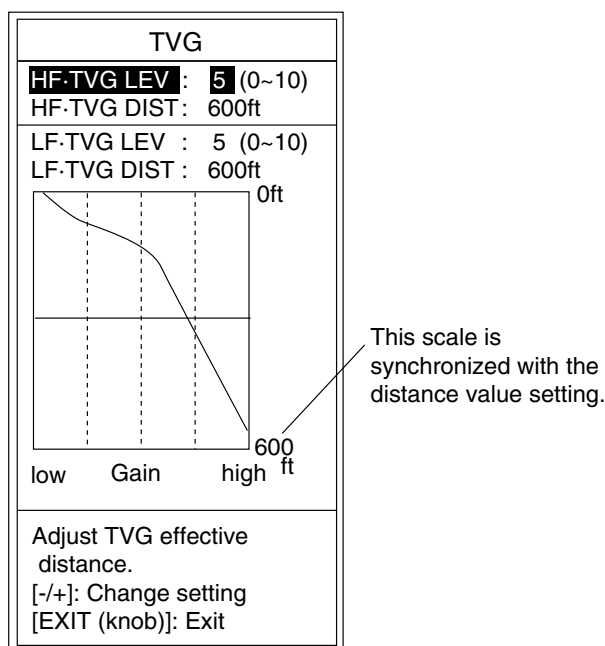

*TVG menu*

- For dual display → Go to step 2.
- For other modes → Go to step 3.

**Note:** When only the picture of the external equipment is displayed, an error message appears on the menu.

2. Press the [▲] or [▼] key to select HF TVG DIST or LF TVG DIST as appropriate.
3. Press the [-] or [+] key to set the TVG available distance.  
The larger the setting, the longer the range at which TVG works. The scale on the menu synchronizes with the rate setting.
4. Press the [▲] or [▼] key to close the window.
5. When surface noise appears in the range shallower than the setting range, press the [▲] key to select HF TVG LEV(EL) or LF TVG LEV(EL) as appropriate.
6. Press the [-] or [+] key to set the TVG level in the setting window (range: 0-10).  
The higher the TVG level, the less the gain near distance.



*TVG level setting window*

7. Rotate the [FUNCTION] switch fully counterclockwise to select EXIT.

## 1.12 Eliminating Weak Echoes

Dirty water or reflections from plankton may be painted on the display in green or light-blue. These weak echoes may be erased with the signal level function.

1. Rotate the [FUNCTION] switch to select SIG LEVEL.

The SIGNAL LEVEL menu appears.

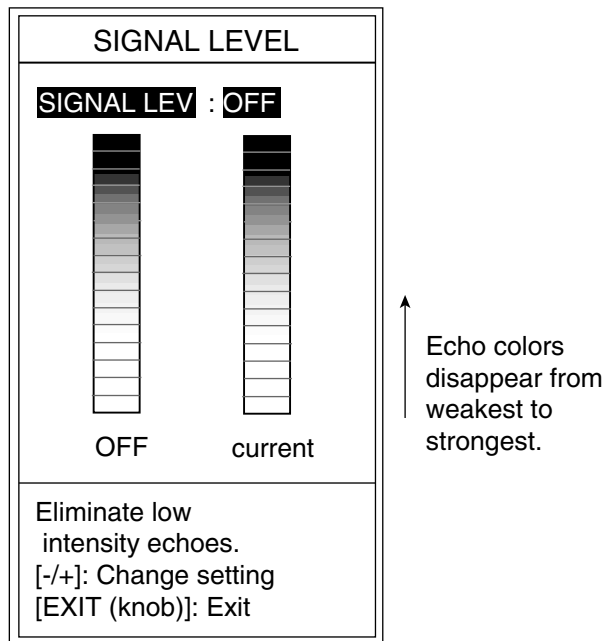

*Signal level menu*

2. Press the [-] or [+] key to select the setting desired.

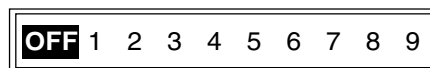

*Signal level setting window (For 16 colors)*

Every pressing of the [+] key deletes echoes from weakest to strongest in ascending order. For eight colors, the setting window shows OFF, 1 to 4.

3. Rotate the [FUNCTION] switch fully counterclockwise to select EXIT.

## 1.13 Picture Advance Speed

The ADVANCE/A-SCOPE function selects picture advance speed.

1. Rotate the [FUNCTION] switch to select ADVANCE/A-SCOPE.

The PIC ADVNC/A-SCOPE menu appears.

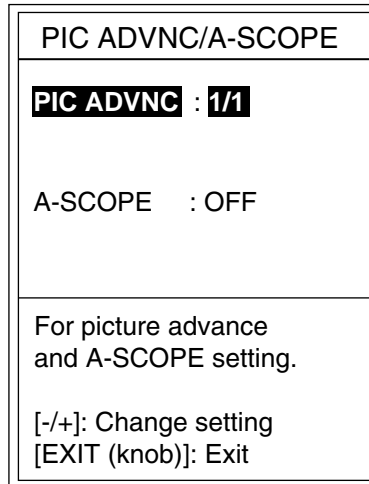

*PIC ADVNC/A-SCOPE menu*

2. Press the [-] or [+] key to select the speed desired.

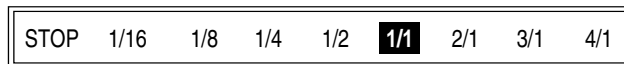

*Picture advance speed setting window*

The fractions in the window mean the number of vertical scan lines produced per transmission. For example, "1/2" means a vertical scan line is produced every two transmissions. These fractions also appear at the top of the screen for your reference.

When selecting an advance speed, keep in mind that a fast advance speed will expand the size of a fish school horizontally and a slow speed will contract it. The current speed appears at the top of the display.

← 1/1 (S) ← "S" means picture advance speed is synchronized with ship's speed.  
See the next page.

*Speed indication*

3. Rotate the [FUNCTION] switch fully counterclockwise to select EXIT.

## Ship's speed dependent mode

With speed data provided by a speed log, current indicator or navigation equipment, the display advance speed may be set according to ship's speed, the ship's speed dependent mode. As shown in the figure below the horizontal scale of the display is not influenced by the change of ship's speed, thus the speed-dependent picture advance permits judgement of fish school size and abundance at any speed. The picture advance speed indication is suffixed with an "S" when the ship's speed dependent mode is active. For example, "1/1S." For how to enable the ship's speed dependent mode see page 2-9. This function is available with ship's speed of 2-20 kt.

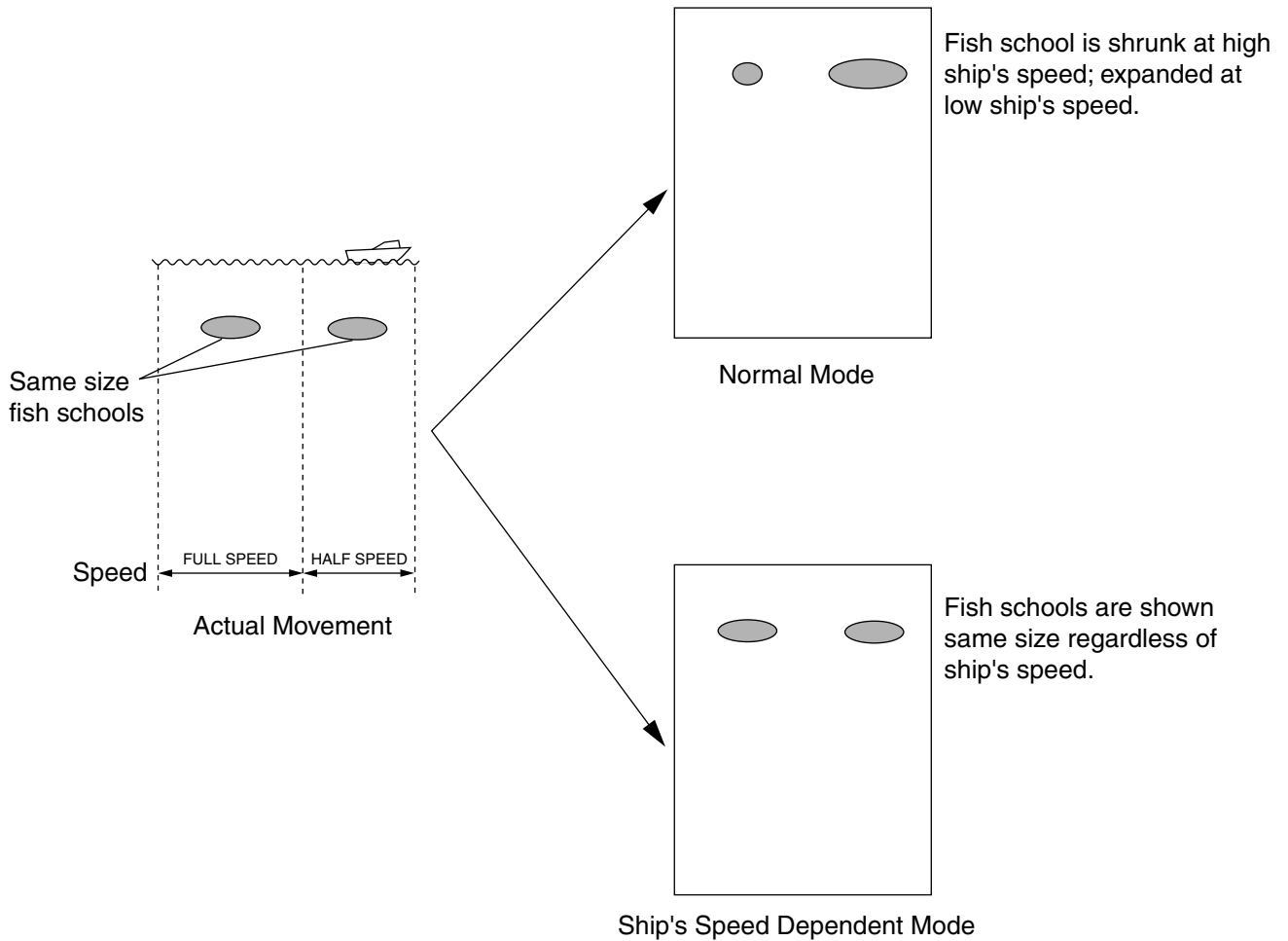

*How the ship's speed dependent mode works*

## 1.14 A-Scope Display

The A-scope picture displays echoes at each transmission with amplitudes and colors proportional to their intensities on the right 1/4 of the screen. This feature is useful for close observation of small fish and fish near the bottom,.

**Note:** For the dual mode display and vertical split screen, the A-scope display is available of the high frequency only. In case of the horizontal split screen, high and low frequency A-scope displays appear.

1. Rotate the [FUNCTION] switch to select ADVANCE/A-SCOPE.  
The PIC ADVNC/A-SCOPE menu appears.
2. Press the [▼] key to select A-SCOPE.
3. Press the [+] key to select ON in the setting window.



*A-scope selection window*

4. Rotate the [FUNCTION] key to select EXIT.  
To turn off the A-scope display, press the [-] key to select OFF at step 3 in this procedure.

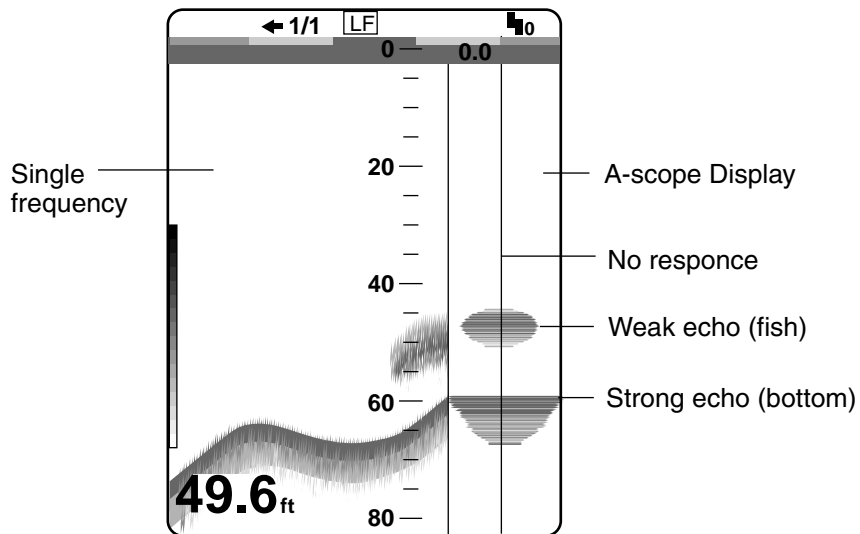

*A-scope display*

## 1.15 Suppressing Interference

Interference from other acoustic equipment operating nearby or other electronic equipment on your boat may show itself on the display as shown in the figure below. You may suppress these types of interference with the noise limiter.

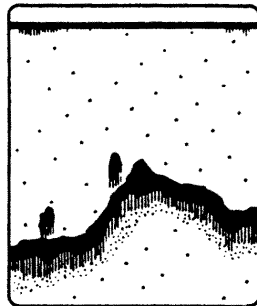

Interference from other sounder



Electrical interference

### Interference

1. Rotate the [FUNCTION] key to select NL.

The NOISE LIMITER menu appears.

NOISE LIMITER	
HF-FREQ ADJ : +0.0%	
▼  ----- -----  -10      0      +10	
HF-NOISE LIM : OFF	
LF-FREQ ADJ : +0.0%	
▼  ----- -----  -10      0      +10	
LF-NOISE LIM : OFF	
1. Shift frequencies to reject interference. 2. Use LF/HF-NOISE LIM in case interference hasn't been rejected. [-/+]: Change setting [EXIT (knob)]: Exit	

The inverted solid triangle shifts with operation of [-] or [+] key.

### NL menu

- For the dual display → Go to step 2.
- For other modes → Go to step 3.

**Note:** When only the picture from external equipment is displayed, an error message appears on the menu.



2. Press the [▲] or [▼] to select HF•FREQ ADJ or LF•FREQ ADJ whichever is appropriate.
3. Press the [-] or [+] key to set appropriate value in the setting window so that interference disappears. (The setting range is -10.0% to +10.0%, however the lowest setting available for the 68 and 200 kHz transducers is -4.5%.)

To adjust interference suppression level finely, go to step 4.

If the interference suppression is sufficient, go to step 7.

4. Press the [▲] or [▼] key to close the setting window.
5. Press the [▼] key to select HF•NOISE LIM or LF•NOISE LIM whichever is appropriate.
6. Press the [-] or [+] key to select the noise rejection setting in the setting window.  
N3 provides the highest level of interference suppression.

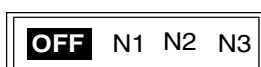

*Signal level setting window*

7. Rotate the [FUNCTION] switch to select EXIT.

**Note:** Turn the noise limiter off when no interference exists, otherwise weak echoes may be missed.

## 1.16 Adjusting the External Video Sounder Picture

The USER-1/USER-2 display can show the picture from external equipment, and you can adjust the picture as below.

1. Display the picture of the external equipment. "EXT" appears at the top of the screen.
2. Rotate the [FUNCTION] switch to select GAIN-EXT.

The EXTERNAL (3rd) ECHO menu appears.

EXTERNAL (3rd) ECHO	
<b>GAIN</b>	: <b>5.0</b> (0 ~ 10)
CLUTTER	: 4 (0 ~ 7)
CURVE	: STD
TVG	: 5 (0 ~ 10)
STC	: 0 (0 ~ 10)
NOISE LIM	: OFF
GAIN ADJ	: +0 ( $\pm 50$ )
TX PULSE	: STD
MANUAL	: 0.2 msec

These settings only appear when the picture from external equipment is displayed.

Optimize external (3rd) echo presentation.  
[-/+]: Change setting  
[EXIT (knob)]: Exit

### *EXTERNAL (3rd) ECHO menu*

3. Press the [ $\blacktriangle$ ] or [ $\blacktriangledown$ ] to select the item to adjust.
4. Press the [-] or [+] key to adjust.
5. Press the [ $\blacktriangle$ ] or [ $\blacktriangledown$ ] to close the window.
6. Rotate the [FUNCTION] switch fully counterclockwise to select EXIT.

### **Items**

GAIN: Adjusts gain (0.0-10.0)	CLUTTER: See page 1-15,
CURVE: See page 1-15	TVG: See page 1-16
STC: See page 2-9	NOISE LIM: Same as NOISE LIMITER. See page 1-22
GAIN ADJ: See page 2-9	TX PULSE, MANUAL: See page 2-10

# 2. MENU OPERATION

---

## 2.1 Basic Menu Operation

The main menu, consisting of the DISP (display), ALM (alarm), TX/RX, USER-1/2 and SYSTEM menus, contains various items which once preset do not require frequent adjustment.

1. Rotate the [FUNCTION] switch fully clockwise to select MENU.

The last-used menu among DISP, ALM, TX/RX, USER-1/2 and SYSTEM appears.

The illustration below shows the DISP menu.

Menu titles —

<b>DISP</b> ALM TX/RX USER-1/2 SYSTEM
ZOOM MODE : BOTTOM LOCK
NO. OF COLORS : 16
HUE : STD
BACKGROUND : BLUE
WHITE LINE : OFF (OFF, 1~10)
DEPTH INFO : STD
BOTTOM SEARCH : AUTO
MARKER SELECT : VRM
AUTO SHIFT : OFF
DISPLAY DATA : TIMER
SCROLL TIME : OFF
SMOOTHING-1 : 3 (OFF,1~8)
SMOOTHING-2 : OFF

Description for selection. —

Menu for display setting.  
[-/+]: Change set, [EXIT (knob)]: Exit

*DISP menu*

2. Press the [ $\blacktriangle$ ] key to select menu title area.
3. Press the [+] or [-] key to select menu desired among DISP, ALM, TX/RX, USER-1/2 and SYSTEM.

The menu selected is highlighted in the menu title area.

4. Press the [ $\blacktriangle$ ] or [ $\blacktriangledown$ ] key to select item. For example, select NO. OF COLORS.

Menu help for the item selected appears at the bottom of the screen.

5. Press the [-] or [+] key to display the setting window. The illustration below shows the selection window for NO. OF COLORS.

8	<b>16</b>
---	-----------

*Selection window (ex. NO. OF COLORS)*

6. Press the [-] or [+] key to change the setting.

For many items having several options, a scroll bar (blue) appears. This bar shows the current cursor position in relation to the entire option range. This bar shifts with operation of [-] or [+] key.

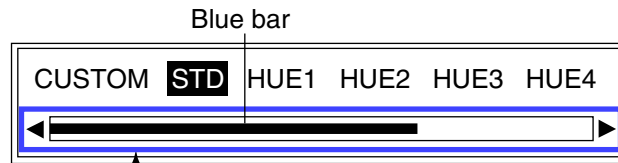

The blue bar shows the current cursor position in relation to the option range.  
This bar shifts with operation of [-] or [+] key.

*Selecting window (for item having several options, ex. HUE)*

7. Rotate the [FUNCTION] switch fully counterclockwise to select EXIT.  
The menu disappears.

## 2.2 DISP Menu

<b>DISP</b> ALM TX/RX USER-1/2 SYSTEM	
ZOOM MODE : BOTTOM LOCK	
NO. OF COLORS : 16	
HUE : STD	
BACKGROUND : BLUE	
WHITE LINE : OFF (OFF, 1~10)	
DEPTH INFO : STD	
BOTTOM SEARCH : AUTO	
MARKER SELECT : VRM	
AUTO SHIFT : OFF	
DISPLAY DATA : TIMER	
SCROLL TIME : OFF	
SMOOTHING-1 : 3 (OFF,1~8)	
SMOOTHING-2 : OFF	
Menu for display setting.	
[-/+]: Change set, [EXIT (knob)]: Exit	

For picture advance speed: 2/1, 3/1, 4/1  
For picture advance speed : 1/16, 1/8, 1/4, 1/2, 1/1

### *DISP menu*

#### **ZOOM MODE**

Selects the zoom mode to show when the [MODE] switch selects ZOOM. Refer to Chapter 1.

#### **NO. OF COLORS**

Selects eight color or sixteen-color presentation.

#### **HUE**

Selects desired picture color. USER displays the colors programmed by the user. (See chapter 3.) STD is the standard colors used on most FURUNO video sounders. HUE 1-7 provide other picture color arrangements.

#### **BACKGROUND**

Selects background color to black, dark blue, blue, light-blue or white. Note that the background color is fixed when the user color (in HUE above) is selected.

#### **WHITE LINE**

Changes the strongest signal color to white. The higher the setting, the wider the white line.

Generally, fish schools on or close to the bottom are displayed on the screen as if they are small rising of the bottoms. This feature can help discriminate bottom fish schools from the bottom.

## **DEPTH INFO**

Changes the size and position of the depth indication.

## **BOTTOM SEARCH**

On the dual frequency display, select transducer which is to measure depth. AUTO, automatic; LOW, low frequency, HIGH, high frequency.

## **MARKER SELECT**

Selects the marker function, VRM or WHITE MARKER.

VRM: Measures depth to an echo.

WHITE MARKER: The echo from a fish school or the bottom can be displayed in white.

### **(White marker operation)**

1. After the selecting EXIT with the [FUNCTION] switch to close the menu, press the [▲] or [▼] key to show the white marker setting window.

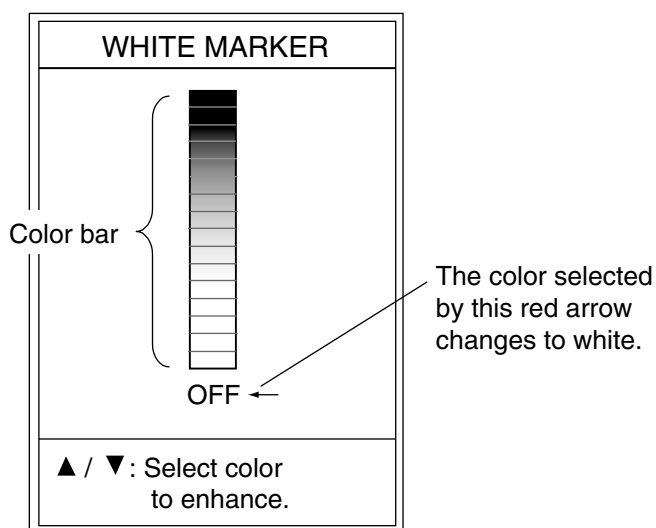

*White marker setting window*

2. Press the [▲] or [▼] key to select the echo color which you want to emphasize.  
The setting window disappears if there is no key operation within five seconds.

The color bar selected to display in white is displayed in white on the color bar.

**Note:** Before changing from WHITE MARKER to VRM, you must select OFF in the white marker setting window.

## AUTO SHIFT

Selects manual or automatic depth shift.

OFF: Shift manually with the [+] or [-] key.

1/4: The display is automatically shifted to place the bottom echo on the lower half of the screen.

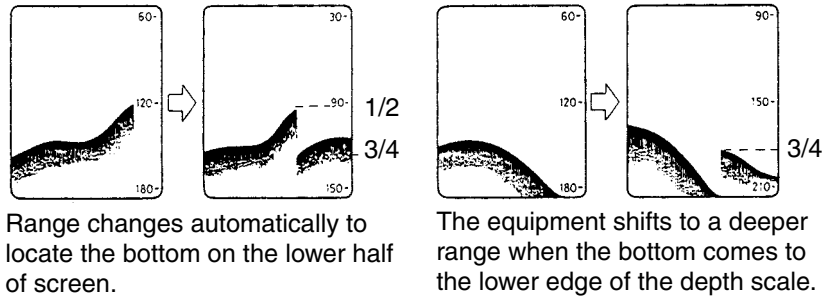

*Automatic shift (1/4)*

1/2: The display is automatically shifted to display the bottom echo on the screen. When the bottom is rough, the bottom echo may be displayed too thinly if the display shift setting is "1/4.". In this case use the "1/2" setting to display the bottom echo clearly.

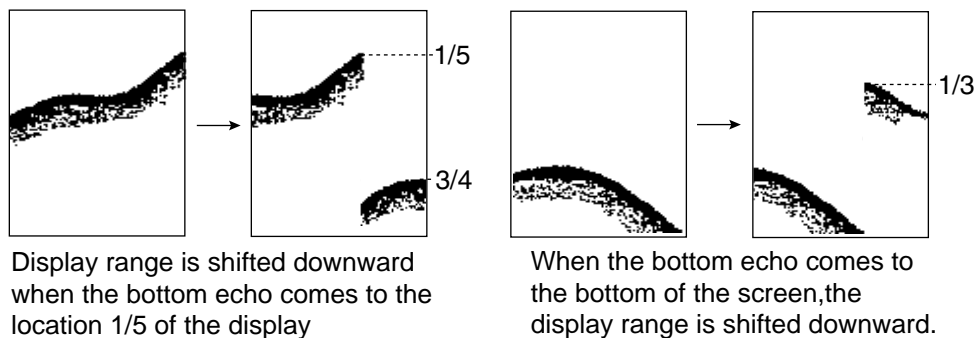

*Automatic shift (1/2)*

## DISPLAY DATA

Selects the data to display at the left top corner of the screen among OFF, L/L\*, TD\*, TIMER (Elapsed time from the moment when the [MARKER/TLL] key is pressed), GAIN\*\*, R/B\* (range and bearing to the waypoint) and COURSE\*.

\*: Requires navigation device.

\*\* : The gain setting shown on the display may not agree exactly with GAIN controller position. When you change the gain setting and then return correctly, using of the setting shown on the display is recommended.

## **SCROLL TIME**

Turns the display scroll time on/off. Scroll time displays, at the screen bottom, the amount of time a scan line stays on the screen as it passes from one side of the screen to the other. Time varies with the range and picture advance speed.

## **SMOOTHING-1**

This setting can only be changed when the picture advance speed is set to 1/16, 1/8, 1/4, 1/2 or 1/1. (See page 1-19.) This function smoothes echo presentation. The higher the number, the greater the smoothing. Adjust the setting when echoes appear "spotty."

## **SMOOTHING-2**

This setting can only be changed when the picture advance speed is set to 2/1, 3/1 or 4/1. (See page 1-19.) This function smoothes echo presentation. Select ON when rough echoes appear.



## 2.3 ALM Menu

Sets the alarms; BOTTOM, FISH and TEMP (temperature). To silence the alarm beep, press the [-], [+], [▲] or [▼] key.

### **BOTTOM ALARM**

When your ship comes in the area of the selected depth, the beep sounds and the indication BTM flashes at the top right corner to draw your attention.

### **FISH ALARM**

FISH ALARM: Fish echoes of yellow or stronger colors (default setting) trigger the alarm.

BTM-FISH ALARM: When fish echoes come in the area which you set above the bottom, the beep sounds and the indication FISH flashes at the top right corner of the screen. (Available mode: bottom lock, discrim 1/2, discrim 1/3)

### **TEMP ALARM**

Selects temperature range which triggers temperature alarm. Alarm is activated (beep sounds and the indication TEMP appears at the top right corner of the screen) when water temperature is above (UP) or below (DOWN) the preset value. This function requires a water temperature sensor.

### 2.3.1 Setting the alarm

1. Rotate the [FUNCTION] switch fully clockwise to select MENU.
2. Press the [▲] key to select the menu title area.
3. Press the [-] or [+] key to select ALM to display the ALM menu.

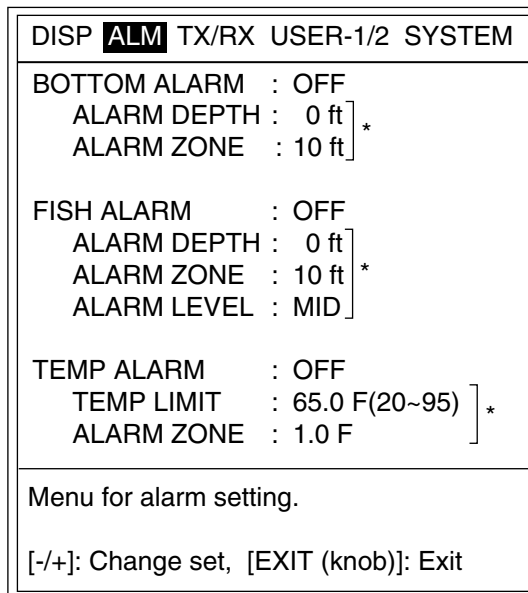

\*: The setting is not available when ALARM is OFF.

*ALM (Alarm) menu*

4. Press the [▲] or [▼] key to select the alarm which you want to set.
5. Press the [-] or [+] key to show the alarm setting window.



Bottom alarm



Fish alarm



Temp alarm

*Alarm setting window*

6. Press the [-] or [+] key to select the alarm type desired.
7. Press the [▼] key twice to select ALARM DEPTH (TEMP LIMIT for temp alarm).
8. Press the [-] or [+] key to show the alarm setting window.

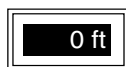

*Starting depth setting window (ex. Depth alarm)*

9. For BOTTOM ALARM and FISH ALARM, press the [-] or [+] key to set the starting point of alarm zone.

Alarm marker appears (Depth alarm: green, Fish alarm: white).

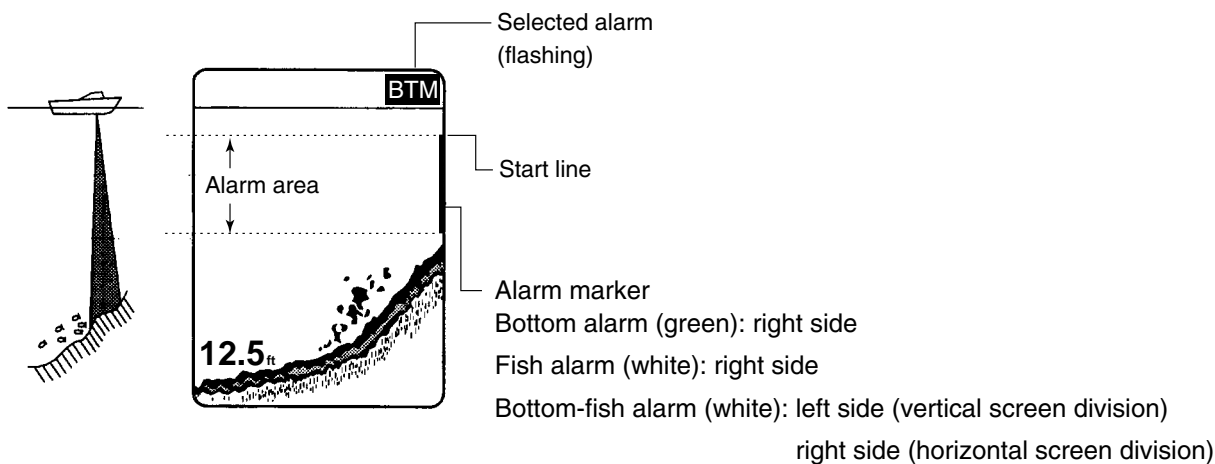

*Setting of alarm zone (ex. Bottom alarm)*

10. Press the [▼] key to select ALARM ZONE.
11. Press the [-] or [+] key to show the alarm zone setting window.

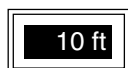

*Alarm zone setting window (ex. Bottom alarm)*

12. Press the [-] or [+] key to set the alarm zone.  
For depth alarm and temp alarm, go to step 16. To set the fish alarm, go to step 13.
13. Press the [▼] key to select ALARM LEVEL.
14. Press the [-] or [+] key to show the level setting window.



*Level setting window*

15. Press the [-] or [+] key to set the alarm level.  
MIN: Alarm triggered against light-blue or stronger fish echoes.  
MID: Alarm triggered against yellow or stronger fish echoes.  
MAX: Alarm triggered against red or stronger fish echoes.
16. Rotate the [FUNCTION] switch fully counterclockwise to select EXIT.  
To cancel an alarm, select OFF at step 6.

## 2.4 TX/RX Menu

DISP	ALM	<b>TX/RX</b>	USER-1/2	SYSTEM
PRR LEVEL	:	2 0	(0~20,S)	
<High Frequency>				
STC	:	0	(0~10)	
GAIN ADJ	:	+ 0		
*1 — RX BAND	:	STD		
TX PULSE	:	STD		
PULSE LENGTH	:	0.2msec	(0.2~5.0)*2	
<Low Frequency>				
STC	:	0	(0~10)	
GAIN ADJ	:	+ 0		
*1 — RX BAND	:	STD		
TX PULSE	:	STD		
PULSE LENGTH	:	0.2msec	(0.2~5.0)*2	
Menu for TX/RX setting.				
[-/+]: Change set, [EXIT (knob)]: Exit				

\*1: FCV-1200L only

\*2: The setting becomes available when MANUAL is selected at TX PULSE.

### *TX/RX menu*

#### **PRR LEVEL**

Changes pulse repetition rate. Normally, the highest rate (20) is used. When in shallow waters second reflection echoes may appear between surface and actual bottom echo. In this case lower the PRR level.

The choice “S” means the ship’s speed dependent mode, where the PRR changes automatically with ship’s speed. (Requires ship’s speed input.) For further information about the ship’s speed dependent mode, see page 1-20.

#### **STC (High and Low Frequencies)**

Adjusts STC level for the high and low frequencies, and is useful for suppressing surface noise. The setting range is 0-10; the higher the setting the greater the extent of suppression. Setting 10 suppresses noise up to about 5 m. Turn off the STC when there is no noise on the screen, otherwise weak echoes may be missed.

#### **GAIN ADJ (High and Low Frequencies)**

Adjusts gain (range: -50 to +50) of transceiver unit selected. Adjust the setting when the GAIN control cannot effectively adjust the gain.

### **RX BAND (High and Low Frequencies)**

Sets amplifier bandwidth of high and low frequency Rx amplifier.

When NARROW is selected, the noise suppression is greater however resolution is lower in shallow water. Normally, set to STD. For more effective resolution, select WIDE.

### **TX PULSE (High and Low Frequencies)**

Sets TX pulselength for high and low frequencies. The available choices are SHORT1, SHORT2, STD, LONG, and MANUAL. Pulselength (without MANUAL) automatically changes with range and shift.

### **PULSE LENGTH (High and Low Frequencies)**



When selecting MANUAL on TX PULSE, this setting (setting range: 0.2 msec – 5.0 msec) is active. The smaller digit, the greater the detection resolution; the larger digit, the longer the detection range.

## 2.5 USER-1/2 Menu

Sets screen division for the dual frequency picture. This setting can be selected with USER-1, 2 of the [FUNCTION] switch. Default settings are as below.

USER-1:  ([LF]+[HF] +[MIX])

USER-2:  ([LF]ZM/NOR+[HF]ZM/NOR)

DISP	ALM	TX/RX	<b>USER-1/2</b>	SYSTEM
<USER-1>				
SCREEN LAYOUT : 				
DISP MODE : [LF]+[HF]+[MIX]				
ZOOM MODE : BOTTOM ZOOM *1				
<USER-2>				
SCREEN LAYOUT : 				
DISP MODE : [LF]Zm/Nor+[HF]Zm/Nor				
ZOOM MODE : BOTTOM ZOOM				
EXT DEVICE : ETR*2				
DEFAULT SET : NO				
Menu for user-preset mode setting.				
[-/+]: Change set, [EXIT (knob)]: Exit				

\*1: The setting is available when Zm (Zoom) is selected at the DISP MODE field.

\*2: The setting is available when EX is selected at the DISP MODE field.

*USER-1/2 menu*

### SCREEN LAYOUT

Selects the screen division layout among the following patterns.



## **DISP MODE**

Selects the picture to display in respective screen layout. See the Appendix 2 at the back of this manual for detailed information.

- |  |   |
|--|---|
| <input type="checkbox"/> [HF]:Normal<br>[LF]:Normal<br>[EX]:Normal*<br>[HF]:Zoom<br>[LF]:Zoom<br>[EX]:Zoom*<br>[MIX]:Normal  | <input type="checkbox"/> [LF]+[HF]:Zm/Nor<br>[LF]:Zm/Nor+[HF]<br>[EX]+[HF]:Zm/Nor*<br>[EX]+[LF]:Zm/Nor*<br>[EX]:Zm/Nor+[HF]*<br>[EX]:Zm/Nor+[LF]*<br>[EX]+[LF]+[HF]*<br>[MIX]+[LF]+[HF]<br>[LF]+[H]sub+[HF]<br>[L]sub+[LF]+[HF] |
| <input type="checkbox"/> [HF]:Zm/Nor<br><input type="checkbox"/> [LF]:Zm/Nor<br><input type="checkbox"/> [EX]:Zm/Nor*<br><input type="checkbox"/> [LF]+[HF]<br>[EX]+[HF]*<br>[EX]+[LF]*<br>[LF]:Zm+[HF]:Zm<br>[HF]+[MIX]<br>[LF]+[MIX]<br>[H]sub+[HF]<br>[L]sub+[LF] | <input type="checkbox"/> [LF]:Zm/Nor+[HF]:Zm/Nor<br><input type="checkbox"/> [HF]:Zm/Nor<br>[LF]:Zm/Nor<br>[EX]:Zm/Nor*   |
- \*: EXIF assy. (option) equipped for FCV-1200L,  
INTERNAL selected at XDCCR CONNECT  
on the E/S DRAFT SETTING menu.

HF: high frequency

LF: low frequency,

NOR: normal

ZM: zoom,

MIX: mix

Sub: gain for fish and seabed echoes is raised

EX: display of external transducer unit or telesounder

### **Gain (sub)**

The [GAIN] control mainly adjusts the bottom echo. When selecting the sub (sub gain), the [GAIN] control adjusts the fish and bottom echoes. At the sub gain mode, press the [-] or [+] key to show the sub gain setting window.

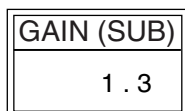

*Sub gain setting window*

Press the [-] or [+] key to select the setting value (0.0-10.0) within five seconds.

## **ZOOM MODE**



Selects the zoom mode to use.

## **EXT DEVICE**

Selects the equipment to use for EX in use mode EX of SCREEN LAYOUT. "EXT" appears at the top of the screen.

ETR: External Transceiver Unit

TS/OTHER: telesounder, external echo sounder, sonar, picture recorder.

**Note:** When selecting  or  screen, the above equipment (low frequency echo) should be connected to the EXT\_H port. The EXT\_L port signal cannot be displayed on those screen layouts.

## **DEFAULT SET**

Restores default settings of the user-1/2 menus. Select YES to restore default settings. Three beeps sounds while default settings are being restored.



# 3. SYSTEM MENU

---

## 3.1 SYSTEM Menu Operation

1. Rotate the [FUNCTION] switch fully clockwise to select MENU.
2. Press the [▲] key to select the menu title area.
3. Press the [+] key to select SYSTEM to show the system menu.

DISP ALM TX/RX USER-1/2 <b>SYSTEM</b>
SYSTEM SETTING ES/DRAFT SETTING RANGE SETTING TEMP SETTING NET SONDE SETTING USER COLOR SETTING USER CLUTTER SETTING ECHO LEVEL SETTING NAV DATA SETTING TARGET ECHO STABILIZATION TEST MODE DEFAULT SETTING
Menu for system setting. [+]: Go to setting [EXIT (knob)]: Exit

### *System menu*

4. Press the [▲] or [▼] key to select the item which you want to set.
5. Press the [+] key to show the sub menu.
6. Rotate the [FUNCTION] switch fully counterclockwise to select EXIT.  
The system menu disappears.

## 3.2 SYSTEM SETTING Menu

This menu mainly sets picture layout parameters.

DISP	ALM	TX/RX	USER-1/2	SYSTEM
SYSTEM SETTING				
<b>LANGUAGE</b>	: ENGLISH			
PICT ADV DIR	: LEFT			
DEPTH SCALE	: RIGHT			
DISP DIVISION	: <input type="checkbox"/>			
ZOOM MARKER	: ON			
FREE SHIFT	: OFF			
ECHO STRETCH	: OFF			
DEPTH UNIT	: ft			
SPEED UNIT	: kt			
TEMP UNIT	: °F			
BOTTOM LEVEL	: +0 (-40 ~ +40)			
RANGE HOLD	: 4(4 - 20)			
Select system language.				
[-/+]: Change set, [EXIT (knob)]: Exit				

Setting may be changed when  
AUTO SHIFT in the DISP menu  
is turned on.

SYSTEM SETTING menu

### LANGUAGE

Selects the language, ENGLISH or JAPANESE. After making selection, rotate the [FUNCTION] switch to select EXIT. This permits switching of language.

### PICT ADV DIR

Selects picture advance direction to left, right or left/right which advances the picture in both right and left directions from the screen center.

### DEPTH SCALE

Selects where to position the depth scale; right, center or off.

### DISP DIVISION

Sets screen division for the dual picture.  vertically divides the screen;  horizontally divides the screen.

## **ZOOM MARKER**

Turns zoom marker on/off.

## **FREE SHIFT**

Set shift value independently for each range (ON) or commonly for all range (OFF).

## **ECHO STRETCH**

Displays the strong echoes long though the pulse length setting is short. It is useful for distinguishing individual fish (e.x. squid) in plankton.

## **DEPTH UNIT**

Selects unit of depth measurement; meters, feet, fathoms, hiro (Japanese), passi/braza.

## **SPEED UNIT**

Selects unit of ship's speed; kt, km/h, sm/h.

## **TEMP UNIT**

Sets unit of water temperature measurement; Celsius or Fahrenheit.

## **BOTTOM LEVEL**

In the default setting "0" the equipment judges consecutive red level echoes to be bottom echoes. In that setting the depth indication may disappear or become unstable if the gain is not raised when the bottom is muddy or sandy. When the gain is raised in this condition, vertical lines extend upward from the bottom in the bottom lock display, as shown in the illustration at right. In this case, lower the bottom detection level to erase the vertical lines. If the level is too low, however, it may be difficult to distinguish bottom fish from the bottom echo. To effectively search for bottom fish, adjust B/L DETECT on the RANGE SETTING menu to erase the vertical lines, instead of lowering the bottom level. For further details see B/L DETECT on page 3-8.

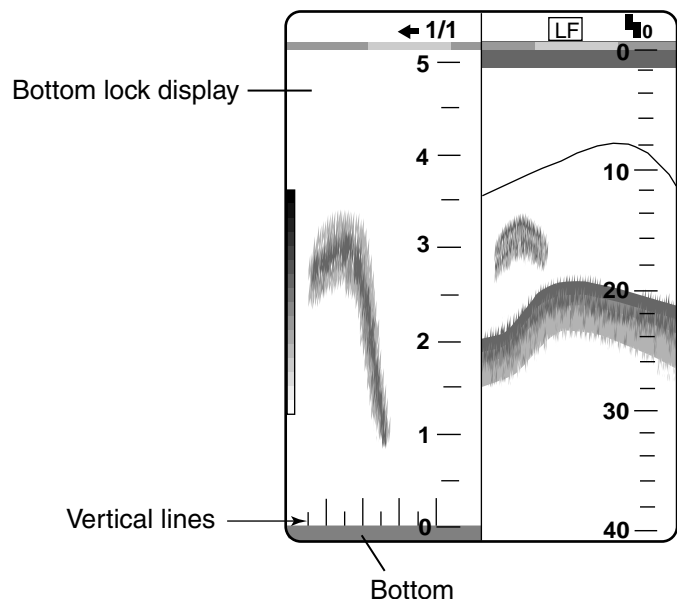

## RANGE HOLD

RANGE HOLD, effective when AUTO SHIFT in the DISP menu is turned on, sets the number of transmissions (4-20) to wait before changing the range when the bottom is lost. Change the setting when it is necessary to have the range changed often (for example, the distance to the bottom changes suddenly) or it is difficult to keep the bottom echo “connected.”

## 3.3 ES/DRAFT SETTING Menu

This menu sets up the transducer and ship’s draft.

DISP ALM TX/RX USER-1/2 SYSTEM	
ES/DRAFT SETTING	
<High Frequency>	
XDCR CONNECT	: INTERNAL
* TX POWER	: MAX
DRAFT	: +0.0 ft (-15 ~ +90)
FREQ CHOICE	: 75 kHz
<Low Frequency>	
XDCR CONNECT	: INTERNAL
* TX POWER	: MAX
DRAFT	: +0.0 ft (-15 ~ +90)
FREQ CHOICE	: 22 kHz
E/S SIG OUT	: OFF
KP SETTING	: INTERNAL
Select transducer connected.	
[-/+]: Change set, [EXIT (knob)]: Exit	

\*: FCV-1200L only

*ES/DRAFT SETTING menu*

### XDCR CONNECT (High and Low Frequencies)

Sets the video sounder to be used for the high and low frequencies, as follows.

INTERNAL: Use the internal video sounder signal (FCV-1200L only).

ETR: Use the video sounder signal from the external Transceiver unit (FCV-1200LM and FCV-1200L with optional EXIF assy. only).

TS/OTHER: Use the video sounder signal from the external telesounder, video sounder or sonar (FCV-1200LM and FCV-1200L with optional EXIF assy. only).

**Note:** Choose INTERNAL when selecting LF, HF or LF/HF at the ES SIG OUT described on the next page.

## **TX POWER (High and Low Frequencies)**

Reduces the power output on high and low frequency (FCV-1200L only). <P/R> appears at the bottom of the screen when MIN is selected. When interference from near another shipborne transducer occurs, set this item appropriately. (MAX→1/2→ 1/4→ 1/8→ 1/16→MIN)

## **DRAFT**

Sets the ship's draft, to show the depth between the sea surface and the bottom (rather than from transducer to bottom). When the picture recorder MT-12 is used to replay the recording data, set the draft to -2.0 ft.

## **FREQ CHOICE**

You can select the transmitting frequencies for the following transducers. Select the frequency to use on this menu.

This function is useful when there is interference from other vessel, or when targeting certain fish species.

### **50kHz/75kHz transducer**

Using the following transducers with 75 kHz provides high resolution.

- 50B-6
- 50/200-1T (50kHz)
- 50/200-1ST(50 kHz)
- 50B-9
- 50B12

### **88 kHz/22 kHz transducer**

Using the following transducer with 22 kHz frequency enables long range detection, a characteristic of low frequency.

- 88B-10

**Note:** When the above transducers are used with 75 kHz or 22 kHz, the transmission line may be longer slightly.

## **E/S SIG OUT**

Outputs selected video sounder signal to external equipment. Default setting is OFF (no output).

In the following cases, the optional EXIF assy. is required for FCV-1200L.

- When telesounder is connected on sister ship.
- When recording video sounder signal by picture recorder.
- When FCV-1200L outputs video sounder signal to other color video sounder.

LF: Outputs the low frequency signal.

HF: Outputs the high frequency signal.

LF/HF: Outputs both the high and low frequency signals.

**Note:** When selecting LF, HF, or LF/HF, select INTERNAL at XDCR CONNECT.

Equipment connected	XDCR CONNECT	E/S SIG OUT	Remarks
External transceiver unit	ETR	-	
Telesounder on sister ship	INTERNAL	LF, HF, LF/HF	Not available on FCV-1200LM
Telesounder on master ship	TS/OTHER	-	
Record by picture recorder	INTERNAL	LF, HF, LF/HF	Not available on FCV-1200LM
Play back by picture recorder	TS/OTHER	-	
Outputs to other E/S	INTERNAL	LF, HF, LF/HF	Not available on FCV-1200LM

## **KP SETTING**

Synchronizes transmission with other echo sounders. Select EXTERNAL to synchronize transmission.

## 3.4 RANGE SETTING Menu

This menu allows the user to preset the range selected with the [RANGE] control.

DISP	ALM	TX/RX	USER-1/2	SYSTEM
RANGE SETTING				
<b>RANGE1</b>	:	<b>30</b>	ft	(16 ~6000)
RANGE2	:	60	ft	
RANGE3	:	120	ft	
RANGE4	:	250	ft	
RANGE5	:	500	ft	
RANGE6	:	1000	ft	
RANGE7	:	1600	ft	
RANGE8	:	3000	ft	
M/Z RANGE	:	16	ft	(16~ 600)
B/L RANGE	:	16	ft	
B/L DETECT	:	STD		
SPLIT RANGE: OFF				
Set preset range scales.				
[-/+]: Change set, [EXIT (knob)]: Exit				

*RANGE SETTING Menu*

**Note:** Hiro is the Japanese unit of depth measurement.

### **RANGE1-RANGE8**

Presets basic ranges for the [RANGE] switch. (5-2000 m, 16-6000 ft, 2-1200 fa, 4-1600 hiro, 3-1200 P/B)

### **M/Z RANGE**

Sets display range of marker zoom and bottom zoom pictures. (5-200 m, 16-600 ft, 2-120 fa, 4-160 hiro, 3-120 P/B)

**Note:** For the vertical split screen, halve the above values.

## **B/L RANGE**

Sets display range of bottom-lock, discrim-1/2, discrim-1/3 picture. (5-200 m, 16-600 ft, 2-120 fa, 4-160 hiro, 3-120 P/B)

**Note:** For the vertical split screen, halve the above values.

## **B/L DETECT**

When vertical lines appear at the bottom of the bottom lock display, you can erase them with B/L DETECT. Enter the length of the lines in the menu. In the example below, the length of the lines is 0.5 meters, so enter "0.5." The setting range is 0.1-20.0.

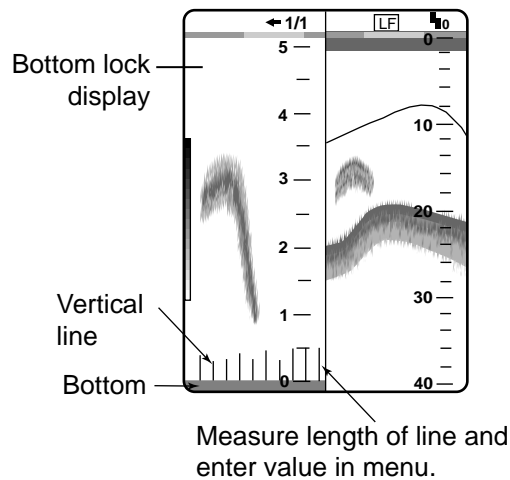

*Bottom lock display*

## **SPLIT RANGE**

Select ON to set range for low frequency and high frequency individually.

1. Rotate the [RANGE] switch to show RANGE (LF or HF) window.

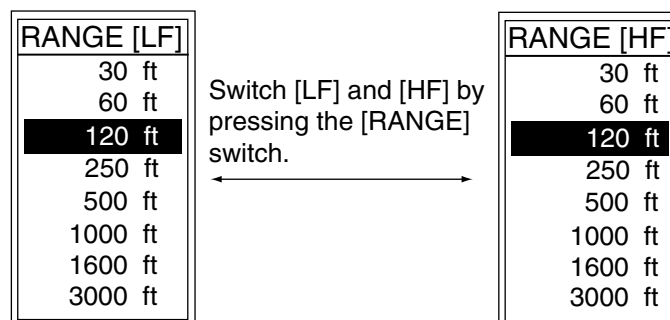

*Range window*

2. Press the [RANGE] switch within five seconds to display the RANGE (LF) window or RANGE (HF) window whichever desired.
3. Rotate the [RANGE] switch to select the range desired.



## 3.5 TEMP SETTING Menu

This menu sets up water temperature sensor.

DISP ALM TX/RX USER-1/2 SYSTEM
TEMP SETTING
TEMP INPUT : SENSOR
TEMP ADJUST : +0.0°F(-20 ~+20)
TEMP READOUT : ON
TEMP GRAPH : OFF
TEMP COLOR : STD
Select temperature sensor.
[-/+]: Change set, [EXIT (knob)]: Exit

*TEMP SETTING menu*

### TEMP INPUT

Selects source of water temperature data; net sonde, sensor, NMEA or CIF.

### TEMP ADJUST

Offsets water temperature indication to improve accuracy. Effective only for net sonde and water temperature sensor. (-20.0 to +20.0°F in 0.1 step)

### TEMP READOUT

Turns on/off water temperature indication.

### TEMP GRAPH

Turns on/off temperature graph and selects graph scale.

OFF: No water temperature graph

NARROW: Graduation every 2°

STD: Graduation every 2.5° (default setting)

EXPAND: Graduation every 5.0°

### TEMP COLOR

Selects the color of the temperature graph (standard, white, red, black, yellow).

**Note:** Standard means the fifth color from the bottom of the color bar, including background color in 16-color display; third color in 8-color display. Yellow means tenth (8-color display: fifth) color from the bottom of the color bar.

## 3.6 NET SONDE SETTING Menu

This menu sets up the Net Sonde.

DISP ALM TX/RX USER-1/2 SYSTEM
NET SONDE SETTING
<b>SONDE MARK</b> : OFF
COLOR : 1
WIDTH : 2
SONDE GRAPH : OFF
GRAPH MODE : SURFACE
GRAPH WIDTH : 1/4
GRAPH RESET : NO
Indication of sonde mark.
[-/+]: Change set, [EXIT (knob)]: Exit

*NET SONDE SETTING menu*

### **SONDE MARK**

Selects where to display the sonde mark; HIGH frequency picture, LOW frequency picture or OFF.

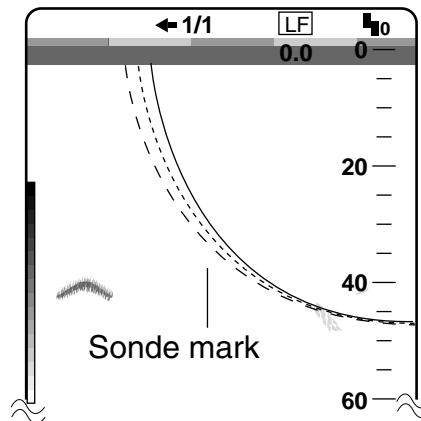

### **COLOR**

Selects number of colors to display net sonde mark; 1 (14 level color), 2 (12 level color) or 3 (10 level color).

### **WIDTH**

Selects the width of sonde mark; 2 dots, 3 dots, 4 dots or 5 dots.

## **SONDE GRAPH**

Turns on/off the net sonde water temperature graph.

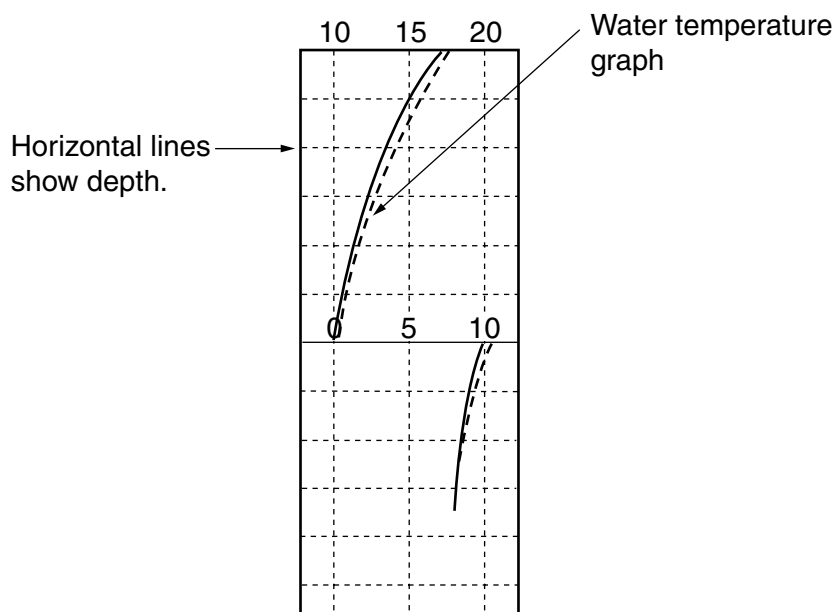

*Net sonde water temperature graph (at the left-hand side of display)*

## **GRAPH MODE**

Selects the display starting position of the net sonde water temperature graph. SURFACE is the first-water temperature (surface condition); BOTTOM the last-written water temperature (net sonde position). The display range is 12 °C and scale interval is 5 °C. For example, if the surface water temperature is 18 °C, the first temperature scale would be 10 °C-20 °C and the display range is 9 °C-21 °C. If the water temperature drops by 9 °C, for example, the next temperature scale would be 0 °C to 10 °C and the display range -1 °C to 11 °C.

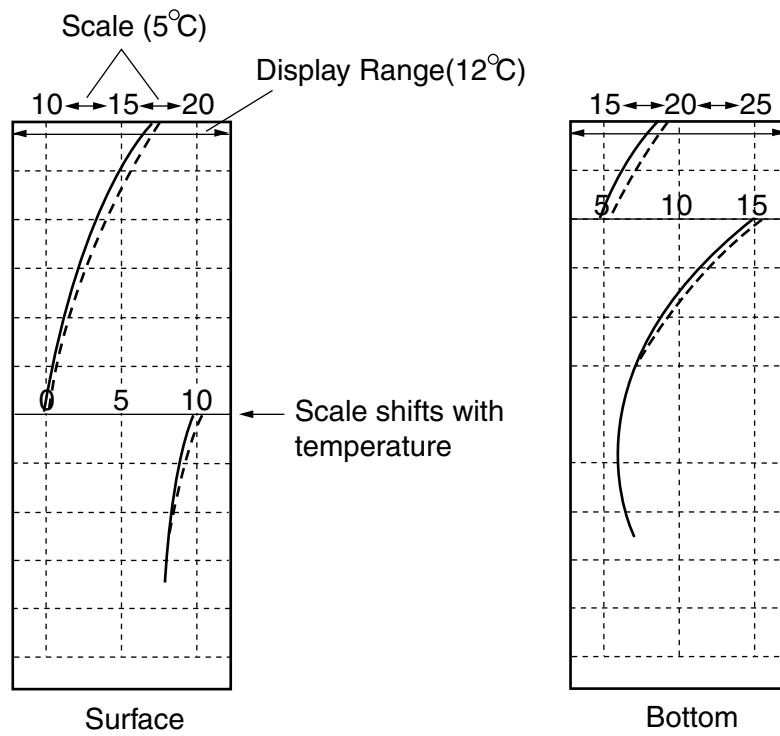

*Net sonde water temperature graph (SURFACE/BOTTOM)*

### **GRAPH WIDTH**

Selects the width of sonde water temperature graph; 1/4 of the screen or 1/2 of the screen.

**Note:** When turning on both of sonde water temperature graph and A-scope, 1/2 is not available.

### **GRAPH RESET**

Select ON to reset the graph.

### 3.7 USER COLOR SETTING Menu

In addition to the standard and factory programmed color sets, the user may set and store display colors as desired and recall them from the DISP menu.

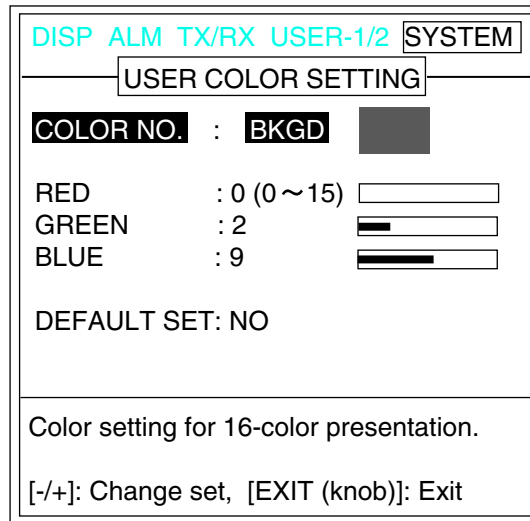

*USER COLOR SETTING menu*

1. Press the [-] or [+] key to show the color setting window.

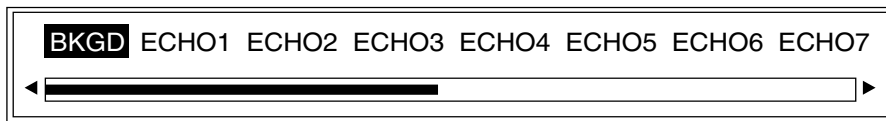

*Color setting window (in case of 16 colors)*

2. Press the [-] or [+] key to select the color to change (background, color 1-14\* and the strongest color).

\*: In case of eight colors, color is 1-6.

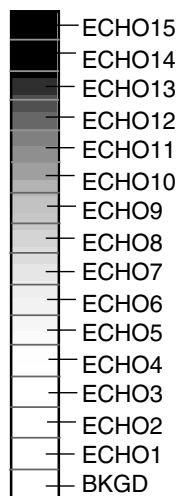

*Color bar (in case of 16 colors)*

3. Press the [▲] or [▼] key to close the color setting window.
4. Press the [▼] key to select RED, GREEN or BLUE (level).
5. Press the [-] or [+] key to show the level setting window.



*Level setting window*

6. Press the [-] or [+] key to select color strength.  
The higher the number, the darker the color.
7. Press the [▲] or [▼] key to close the level setting window.
8. Do steps 4-7 to adjust other color..
9. To return to original color, select YES at DEFAULT SET.

## 3.8 USER CLUTTER SETTING Menu

The USER CLUTTER SETTING menu lets you emphasize weak to medium strength echoes. The settings of this menu are active when selecting CUSTOM on the CLUTTER menu.

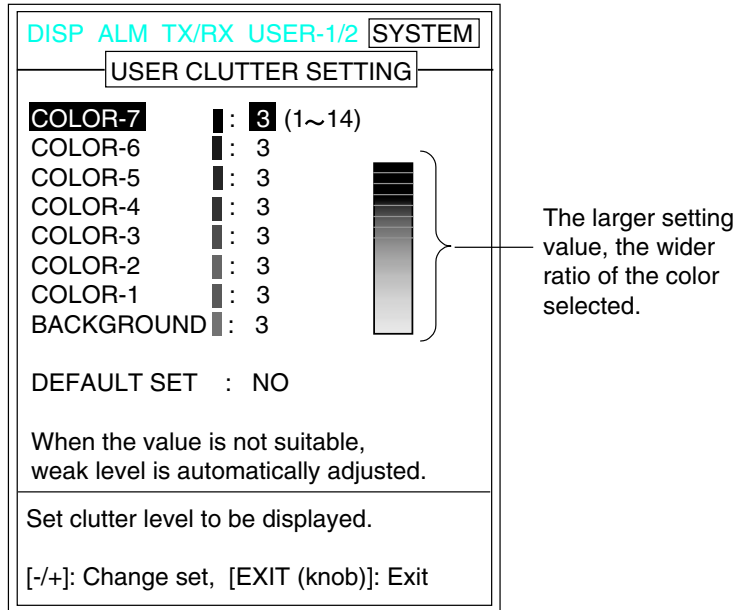

*USER CLUTTER SETTING menu*

1. Press the [ $\blacktriangle$ ] or [ $\blacktriangledown$ ] key to select color or background to change. COLOR-7 is the strongest color.
2. Press the [-] or [+] key to show the setting window.

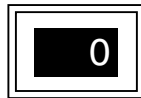

*Setting window*

3. Press the [-] or [+] key to set the level (1-14).

If	then
you want to emphasize COLOR-7 (reddish brown, red)	COLOR-7, COLOR-6: set large value. COLOR-5 to COLOR-1: set small value.
you want to emphasize middle color (yellow, green)	COLOR-7 to COLOR-5: set small value. COLOR-4 and COLOR-3: set large value. COLOR-2 and COLOR-1: set small value.
you want to remove the weakest color	COLOR-1: set small value.

4. Press the [ $\blacktriangle$ ] or [ $\blacktriangledown$ ] key to close the setting window.
5. Repeat steps 1 through 4 to set other color.  
To return to default setting, select YES at DEFAULT SET.

## 3.9 NAV DATA SETTING Menu

This menu selects source of position data and heading data.

DISP ALM TX/RX USER-1/2 SYSTEM
NAV DATA SETTING
<b>SPEED INFO</b> : OFF
NMEA VERSION : Ver 2.0
NAV DATA : AUTO
COURSE : TRUE
TLL OUTPUT : OFF
Indication of speed data.
[-/+]: Change set, [EXIT (knob)]: Exit

*NAV DATA SETTING menu*

### **SPEED INFO**

Turns on/off the ship's speed indication.

### **NMEA VERSION**

Selects NMEA version of external equipment; Ver 1.5, Ver 2.0 or SPECIAL. If you are not sure of version number try both and select which one successfully receives data. SPECIAL outputs the depth data with 600 bps.

### **NAV DATA**

Selects source of navigation data (NMEA talker); Loran C, Loran A, Decca, GPS, DR or AUTO. Select AUTO when more than one talker data is input. The order of priority is GPS, Loran C, Loran A, Decca DR.

### **COURSE**

Selects heading reference; TRUE or MAG (magnetic bearing).

### **TLL OUTPUT**

Enables/disables output of L/L position to a navigation plotter when the [MARKER/TLL] key is pressed.



## 3.10 TARGET ECHO SETTING Menu

The TARGET ECHO menu sets equipment objective. Four choices are available: NORMAL, SURFACE, SQUID and DEEP SEA.

DISP ALM TX/RX USER-1/2 SYSTEM
TARGET ECHO
<b>TARGET ECHO : NORMAL</b>
SURFACE is valid when proper transducer is connected.
Select target echo to optimize sounding parameters. [-/+]: Change set, [EXIT (knob)]: Exit

*TARGET ECHO menu*

Note: Select SURFACE only when both of the transducers (1 kW) below are used. The SURFACE can be used to detect small surface fish. The pulse repetition rate is greater than NORMAL.

- 50/200-1ST
- 50/200-1T
- 200B-5S
- 50B-6
- 50B-9/9B
- 50B-8G
- 50/200/400

## 3.11 STABILIZATION Menu

The stabilization feature offsets heaving (ship's vertical movement) to give you steady images in rough seas. This feature requires connection of a satellite compass.

**NOTICE:** The stabilizer cannot be used in the following instances:

- Picture from external source is being displayed
- Two-split screen of LOW: ZOOM+HIGH: ZOOM
- Three-split screen of EXT+LOW+HIGH
- Four-split screen of LOW: ZOOM/NORMAL+ HIGH: ZOOM/NORMAL
- TARGET ECHO is set for SURFACE
- NMEA VERSION in the NAV DATA menu is set for SPECIAL.
- Heaving data is not input from the satellite compass

DISP	ALM	TX/RX	USER-1/2	SYSTEM
STABILIZATION				
STABILIZATION		: OFF		
SENSOR		: SC50/110		
<p>&lt;High Frequency&gt;</p> <p>ANT-TD LONG. : 0.0m (-100 - +100)</p> <p>ANT-TD TRNSV. : 0.0m (-100 - +100)</p> <p>ANT-TD HEIGHT : 0.0m (0 -100)</p>				
<p>&lt;Low Frequency&gt;</p> <p>ANT-TD LONG. : 0.0m (-100 - +100)</p> <p>ANT-TD TRNSV. : 0.0m (-100 - +100)</p> <p>ANT-TD HEIGHT : 0.0m (0 -100)</p>				
Turn on/off stabilization mode.				
[+]: Go to setting [EXIT (knob)]: Exit				

**STABILIZATION:** Turn the stabilization mode on or off. Turn it on when in rough seas, to get stable bottom echo presentation. The symbol  appears at the top of the screen when the stabilization mode is active.

**SENSOR:** Select the satellite compass interfaced with this equipment.

**ANT-TD LONG., ANT-TD TRNSV., ANT-TD HEIGHT:** These items are set during the installation. It is recommended to maintain the settings set at installation.

# 4. INTERPRETING THE DISPLAY

This section provides, using typical examples, information necessary for interpreting the display.

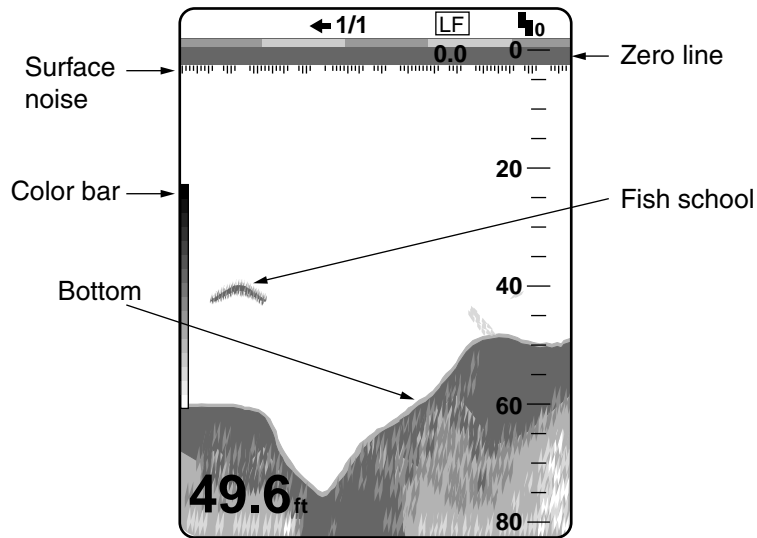

Typical display

## 4.1 Color Bar

The color bar shows the relation between echo intensity and echo color on the screen. The top color (reddish brown) is the strongest color and the lower colors the weakest. The bar can be used as a reference to estimate density of a fish school, fish species and hardness of the bottom. The background color can be selected on the menu screen.

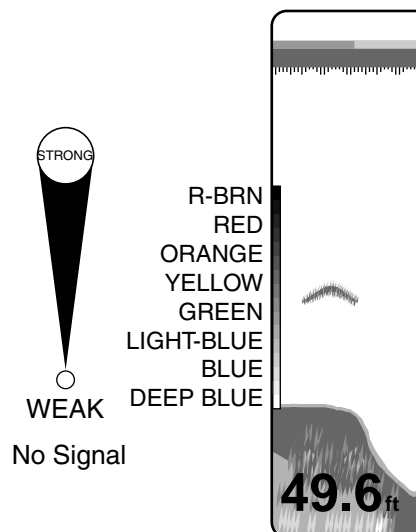

Color bar

## 4.2 Zero Line

The zero line represents the transducer's position. It moves off the screen when a shifted range is used, or is shown at draft depth when ship's draft is entered.

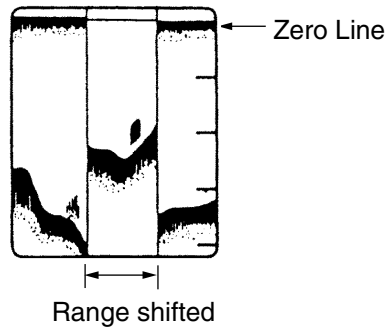

*Zero line*

## 4.3 Bottom Echoes

Bottom echoes are normally strongest and displayed in reddish brown or red, but colors and width will vary with bottom material, depth, sea condition, installation, frequency, pulselength and sensitivity.

### Bottom profile

A hard and rough bottom appears with a longer tail because it reflects more of the ultrasonic pulse. Because of their stronger return, shallow echoes appear wider than deep ones even when all bottom conditions are equal. Also, a longer bottom tail appears on slopes because of the difference in traveling time at both edges of the beam angle. In the rugged bottom, echoes are reflected on many different planes, overlapping to present a 3D effect.

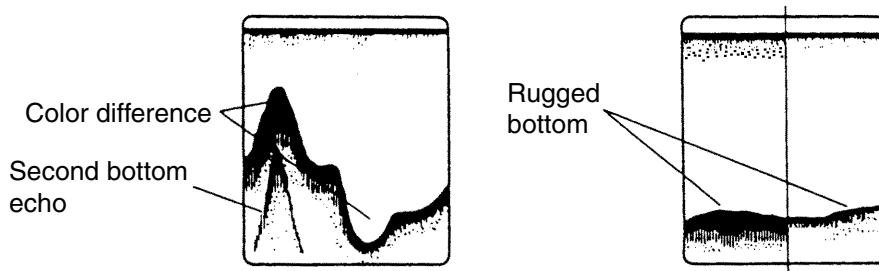

*Bottom material and bottom profile*

## Bottom nature

The nature of the bottom is known from the intensity and length of the bottom tail. Generally, when observing the bottom nature, the lower sounding frequency is used, the pulse length is set to long, and the gain setting is not disturbed. In the hard and craggy bottom, the bottom appears more reddish and with a long tail. However, the bottom with a sediment may give a short tail if a low frequency sounding is used.

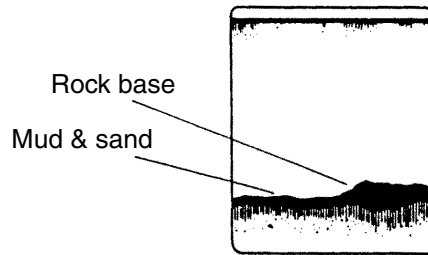

*Bottom nature*

## 4.4 Fish Schools

### Fish quantity

Fish quantity can be estimated to a certain extent from fish echoes on the screen if fish school size and fish school density are kept in mind.

### Fish school size

Usually the size of fish echoes on the screen is proportional to the actual size of the fish school. However, if two fish echoes appear at different depths with the same size, the fish school at shallower depth is smaller because the ultrasonic beam widens as it propagates and a fish school in deep water is displayed larger.

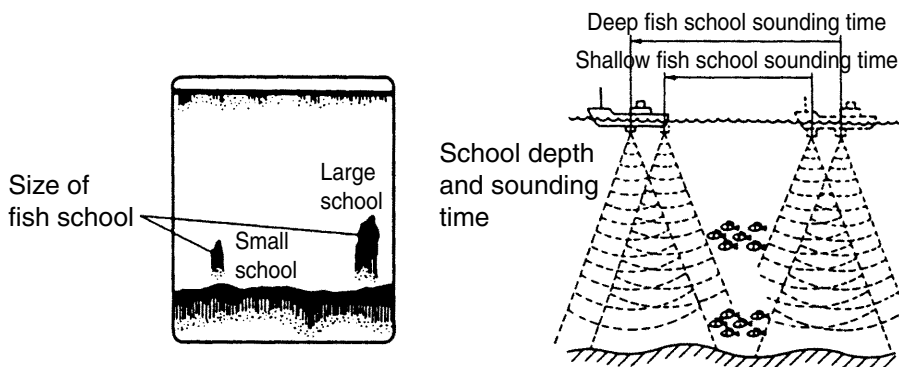

*Fish school size*

*Difference of fish school sounding times*

## Fish school density

If two fish schools appear with the same color at different depths, the one in deeper water is denser because the ultrasonic wave attenuates as it propagates and the fish school in deep water tends to be displayed in a weaker color.

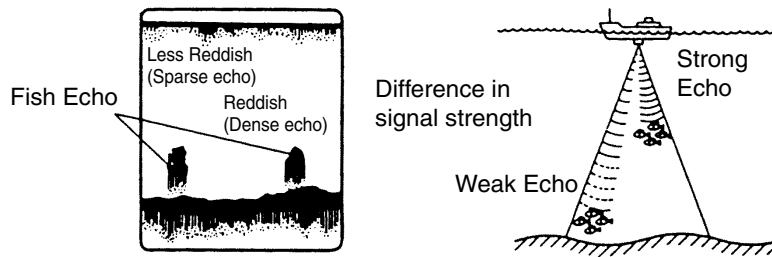

*Fish school density*

## 4.5 Other Echoes

### Plankton

A plankton layer, a likely place to find fish, is displayed in green or blue dots. It usually descends in the day and rises at night.

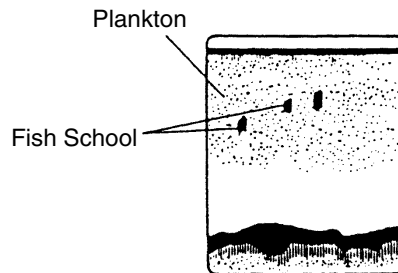

*Plankton*

### Current rip

When two ocean currents meet with different speeds, directions and water temperatures, a current rip develops. A current rip's on-screen appearance is as shown below.

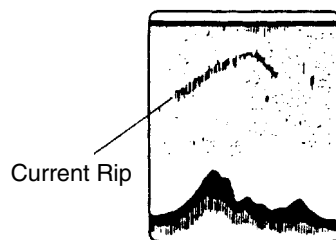

*Current rip*

## Surface noise

When the sea is rough or the ship passes over a wake, surface noise may appear at the top of the screen. It can be suppressed with the CLUTTER function.

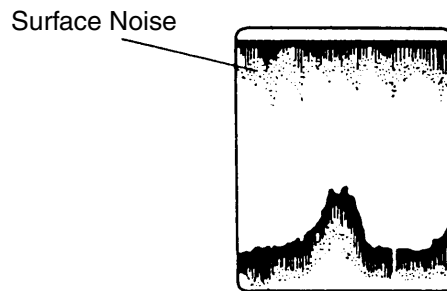

*Surface noise*

## Aerated water

When the sea is rough or the ship makes a quick turn, gaps in the bottom echo on the screen may appear. This is caused by air bubbles which block propagation of the sound wave. Generally low frequency ultrasonic waves are interrupted more easily than high ones.

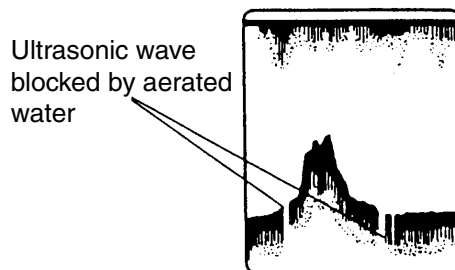

*Aerated water*

## False image

Every time the ultrasonic pulse is transmitted, some radiation escapes on each side of the beam, called "side lobes." Echoes from side lobes show on the display as false images as below.

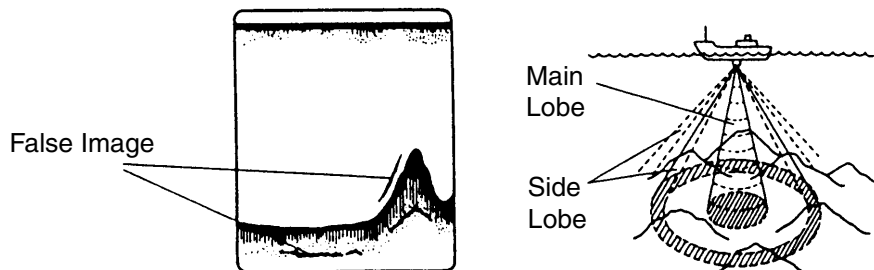

*False images*

This page is intentionally left blank.



# 5. MAINTENANCE & TROUBLESHOOTING

---



## 5.1 Maintenance

Regular maintenance is important for continued performance. Important points to be checked from time to time are shown below.

Check point	Action	Interval
Transducer cable	If conductors are exposed, replace cable.	Monthly
Power cable plug, transducer cable plug	If loosened, secure tightly.	Monthly
Grounding	If corroded, clean.	Monthly
Ship's mains voltage	If out of ratings, correct problem.	Monthly
Transducer cleanliness	Marine life on the transducer will result in a gradual decrease in sensitivity. Check the transducer face each time the boat is drydocked. Carefully remove any marine life with piece of wood or fine sandpaper.	At dry-dock
Display unit cleanliness	Dust or dirt may be removed with a soft cloth. Water-diluted mild detergent may be used if desired. DO NOT use chemical cleaners to clean the display unit; they may remove paint and markings. Use special care when cleaning the LCD, since it scratches easily.	As necessary
LCD screen	Wipe the LCD carefully to prevent scratching, using tissue paper and an LCD cleaner. To remove dirt or salt deposits, use an LCD cleaner, wiping slowly with tissue paper so as to dissolve the dirt or salt. Change paper frequently so the salt or dirt will not scratch the LCD. Do not use solvents such as thinner, acetone or benzene for cleaning.	

## 5.2 Fuse Replacement

A fuse in the display unit and processor unit protects the equipment against overcurrent and reverse polarity of the ship's mains or internal fault. If a fuse blows find the cause before replacing it.

 <b>CAUTION</b>
<b>Use the proper fuse.</b>
Use of a wrong fuse can cause fire or equipment damage.

Location of fuse	Replacement	Type
On the circuit board in the display unit	Contact your dealer.	FGMB 3A 125VAC
In the processor unit	Unscrew the fuse holder on the processor unit to replace fuse. If the fuse blows again after replacement, contact your dealer.	FGMO 15A 125VAC

## 5.3 Troubleshooting

This section provides simple troubleshooting procedures which the user may follow to restore normal operation.

If...	Then...
there are no echoes but the scale appears	<ul style="list-style-type: none"> <li>● check if the transducer is properly connected.</li> </ul>
there is no zero line or zero line is not in correct position	<ul style="list-style-type: none"> <li>● check if the range shifted. (Zero line does not appear when the range is shifted.)</li> <li>● press the [-] key so as the scale appears from 0.</li> </ul>
you suspect low sensitivity	<ul style="list-style-type: none"> <li>● check that gain control is properly set.</li> </ul>
the bottom is traced in zigzag pattern or you experience occasional loss of echo	<ul style="list-style-type: none"> <li>● the sea may be rough. Bottom is traced zigzag when the sea is rough.</li> <li>● own boat may have passed over other boat's wake, which blocks propagation of sound wave.</li> </ul>
there is no depth readout	<ul style="list-style-type: none"> <li>● check to see if bottom is present on the normal picture range.</li> <li>● check if bottom echo is strong enough (red, reddish brown in color).</li> </ul>
automatic shift is inoperative	<ul style="list-style-type: none"> <li>● check if bottom echo is strong enough (red, reddish brown in color)</li> </ul>
picture is distorted	<ul style="list-style-type: none"> <li>● check if magnetic field generating equipment (transformer, rectifier) are nearby.</li> </ul>
color is strange in a given area	<ul style="list-style-type: none"> <li>● check if a magnet is near the equipment.</li> </ul>
occasional noise is seen	<ul style="list-style-type: none"> <li>● check if the cables of pulse generating equipment are near the equipment.</li> </ul>
there is noise and interference	<ul style="list-style-type: none"> <li>● check that GAIN and CLUTTER properly adjusted.</li> <li>● check the setting of the noise limiter.</li> <li>● check the equipment's ground.</li> </ul>

## 5.4 Diagnostic Test

The diagnostic test checks the equipment for proper operation.

1. Rotate the [FUNCTION] switch fully clockwise to select MENU.
2. Press the [▲] key to select the menu title area at the top of screen.
3. Press the [+] key to select SYSTEM.
4. Press the [▲] or [▼] key to select TEST.
5. Press the [+] key to open the test menu.

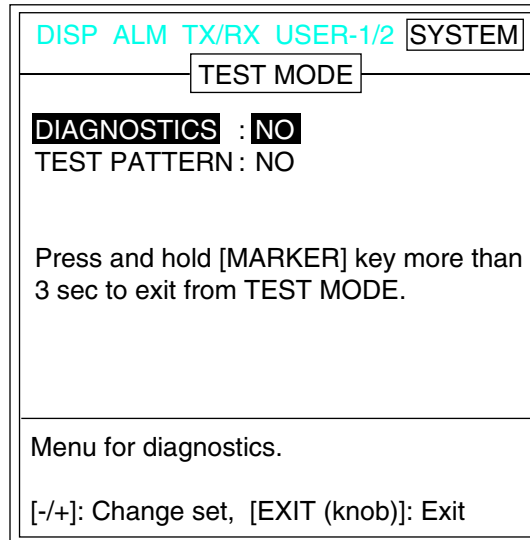

*Test menu*

6. Press the [+] key twice to select YES in the setting window.  
The test screen appears.

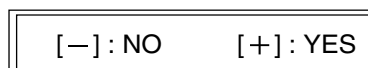

*Test setting window*

Program No.	0252296-0XX		
Panel Unit	Ver XX OK	*	0 0
R O M	OK	0	0
S R A M	OK	0	0
D R A M	OK		
E S 1	OK 15-200*		8
E S 2	OK 15-200*		
E X I F	OPEN		0 0
N M E A	OK		5
SONDE (CIF)	OK		
Temp. SENSOR	+32.6 F	61	86
Temp. SONDE	+31.6 F		

Press and hold [MARKER] key more than 3 sec to exit.

XX: Version No.

\*: Frequency from the transducer connected.

- ROM, SRAM, DRAM test results are shown as OK or NG (No Good).
- ES1, ES2: ES1/2 Board connection test results are shown as OK or OPEN. (For FCV-1200LM, OPEN only.) When test result is OK, the frequency of ES Board appears; 15-200 or 400.
- EXIF: Test results are shown as OK or OPEN (no EXIF assy connection). For FCV-1200LM, OK appears.
- NMEA\*, SONDE (CIF)\* test results are shown as OK. Nothing appears in case of error or no connection. \*requires special test connector.

## Panel test

The "Panel" column at the right of the diagnostics display is used to check keys and controls.

1. Press any key except the [POWER] key. The pressed key's on-screen location changes from 0 to 1 when the key is pressed.
2. Operate the controls. For the controls the figure on the screen changes as below.
  - [FUNCTION] :1 to 8
  - [RANGE] : 0 to 20
  - [MODE] : 1 to 7
  - [GAIN] : 0 to 127
3. Press the [MARKER/TLL] key more than three seconds to return to the SYSTEM menu.
4. Rotate the [FUNCTION] switch fully counterclockwise to select EXIT.

## 5.5 Test Pattern

The test pattern tests for proper display of colors.

1. Rotate the [FUNCTION] switch fully clockwise to select MENU.
2. Press the [▲] key to select the menu title area at the top of the screen.
3. Press the [+] key to select SYSTEM.
4. Press the [▲] or [▼] key to select TEST.
5. Press the [+] key.
6. Press the [+] key to select TEST PATTERN.
7. Press the [+] key twice to select YES in the dialog box.



*Test pattern selection dialog box*

8. Press the [+] key to change the test pattern.

The test pattern changes in the sequence below.

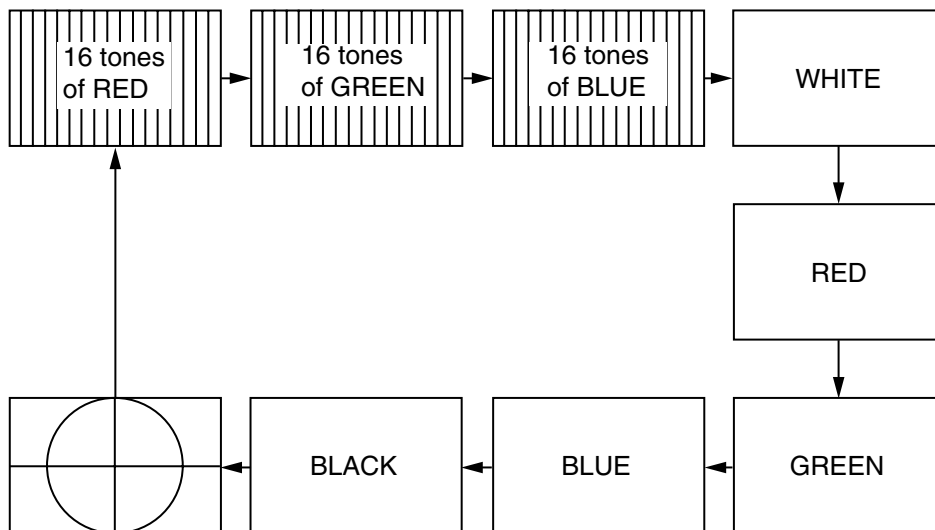

*Test pattern sequence*

9. Press the [MARKER/TLL] key more than three seconds to return to the system menu.
10. Rotate the [FUNCTION] switch fully counterclockwise to select EXIT.

## 5.6 Default Setting

The memory (all menu settings) can be cleared to start afresh. All default menu settings are restored when the memory cleared. For your reference all default settings are shown in the menu tree at the back of this manual.

**Note:** User color setting, language, target echo setting and user clutter setting are not disturbed.

1. Rotate the [FUNCTION] switch fully clockwise to select MENU.
2. Press the [▲] key to select the menu titles at the top of the menu.
3. Press the [+] key to select SYSTEM.
4. Press the [▼] key to select DEFAULT SETTING.
5. Press the [+] key to show the DEFAULT SETTING menu.

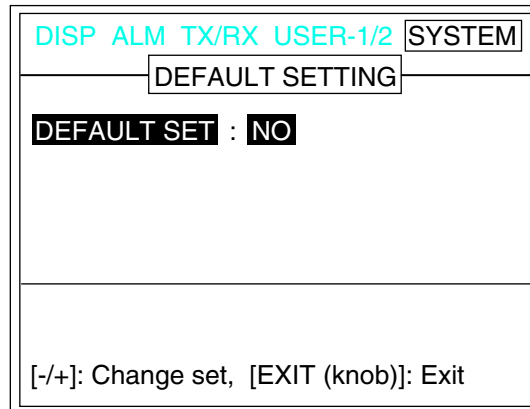

*Default setting menu*

6. Press the [+] key twice to select YES in the selection window.

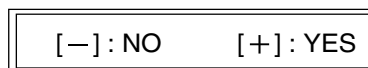

*Selection window*

Alarm beeps three times while the memory is being cleared.

7. Rotate the [FUNCTION] switch fully counterclockwise to select EXIT.

This page is intentionally left blank.



# APPENDIX 1 MENU TREE

[FUNCTION] switch

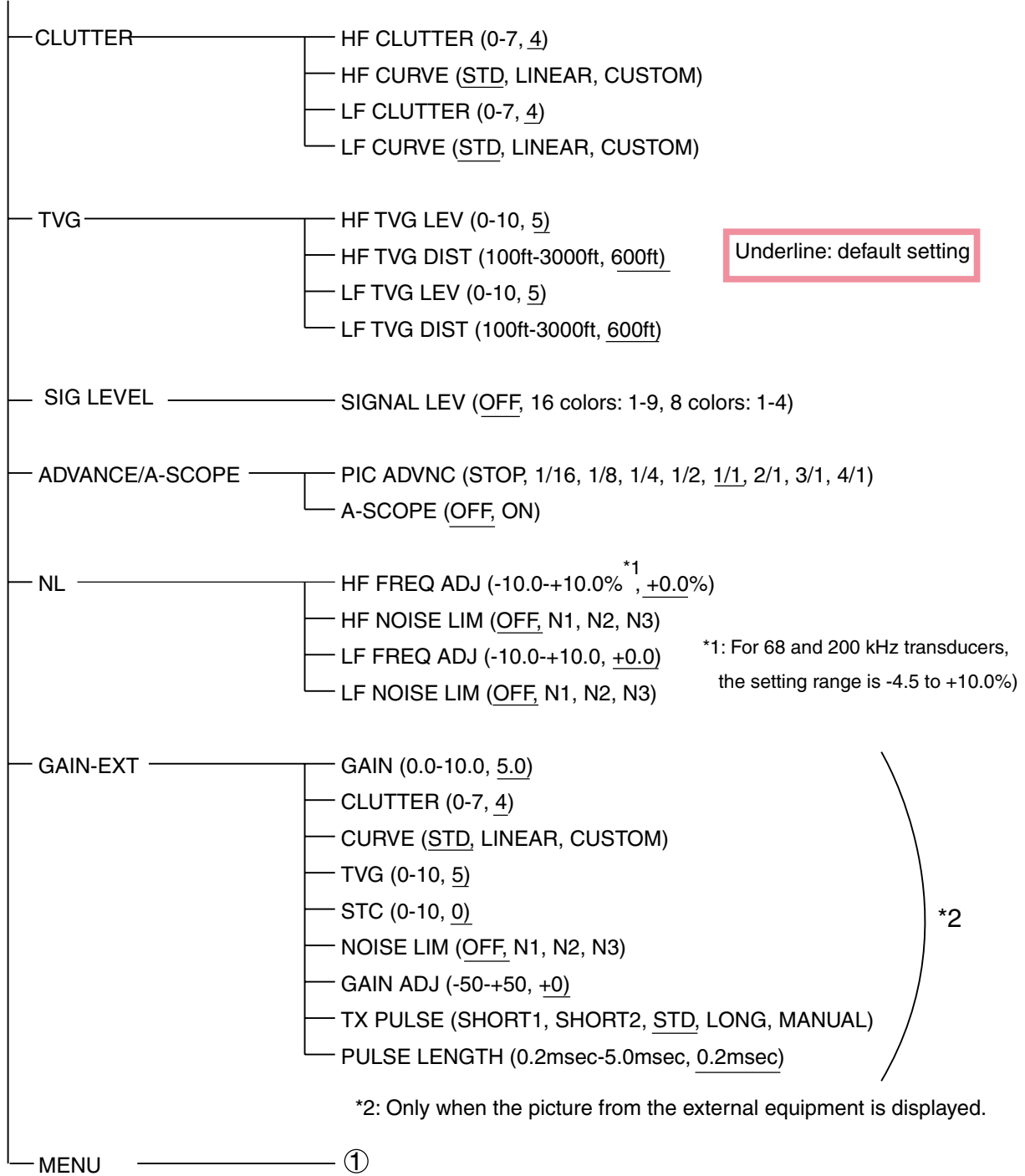

(Continued on the next page.)

(Continued from previous page)

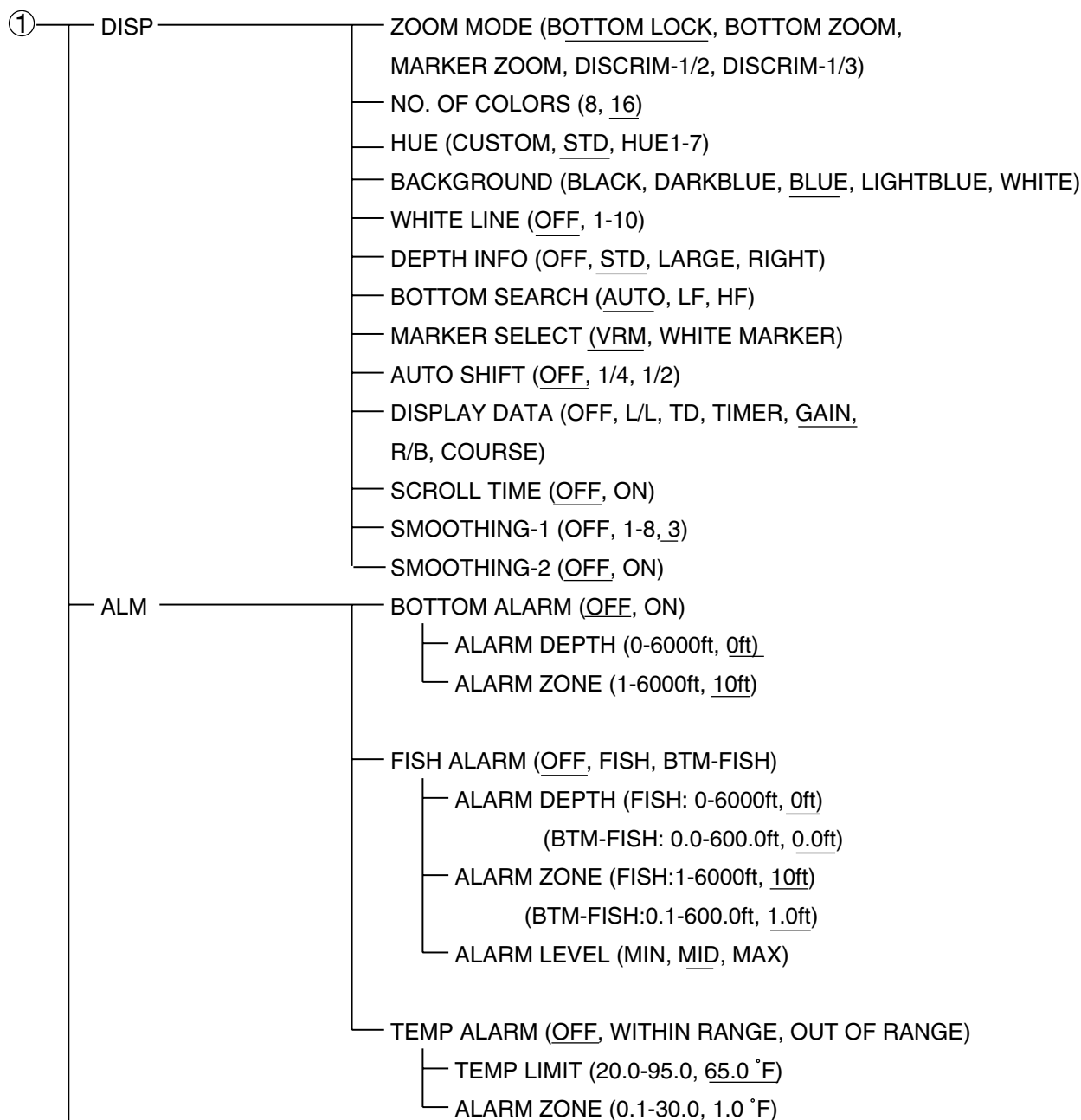

(Continued on the next page)

(From the previous page)

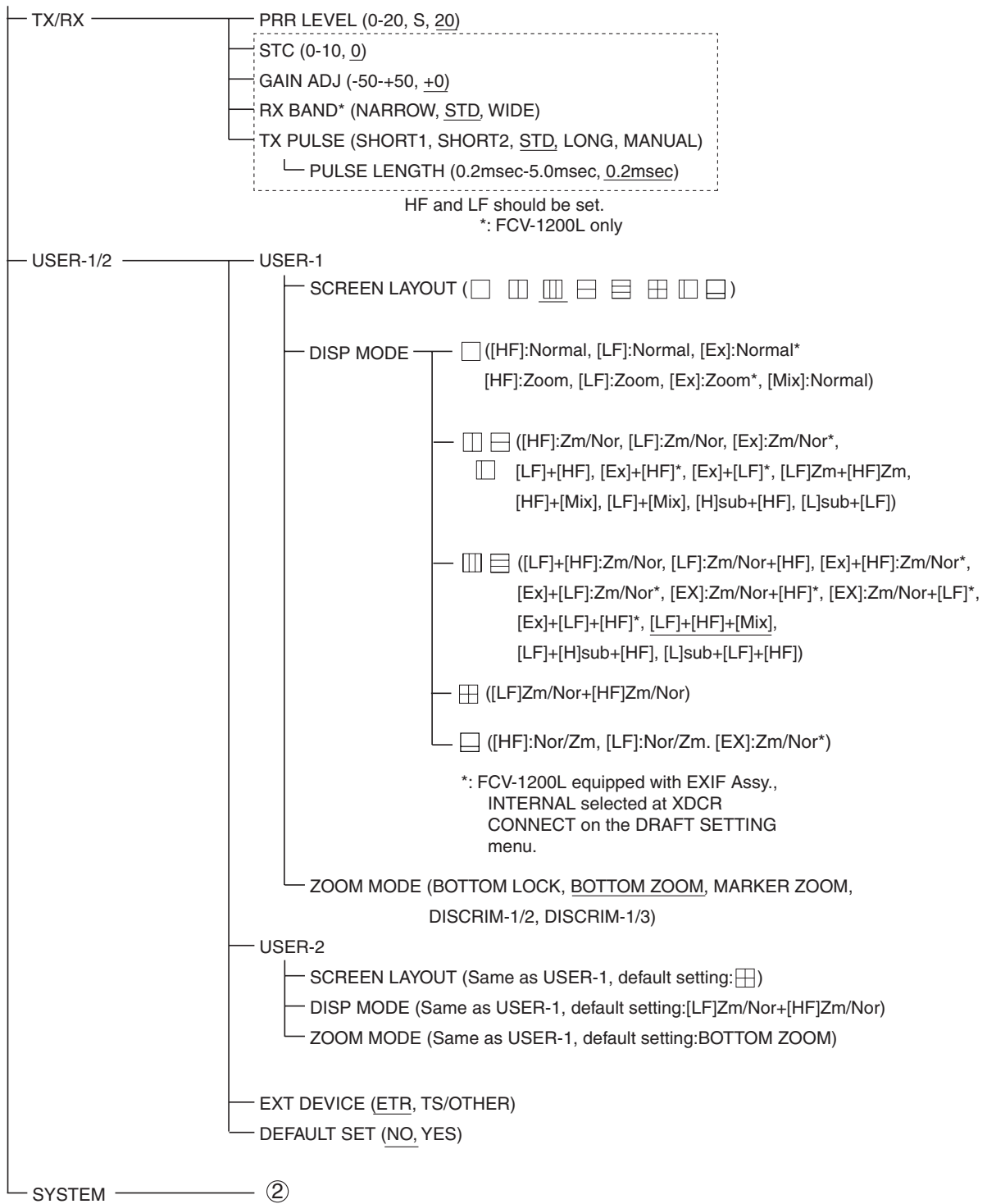

(Continued on the next page)

(Continued from the previous page)

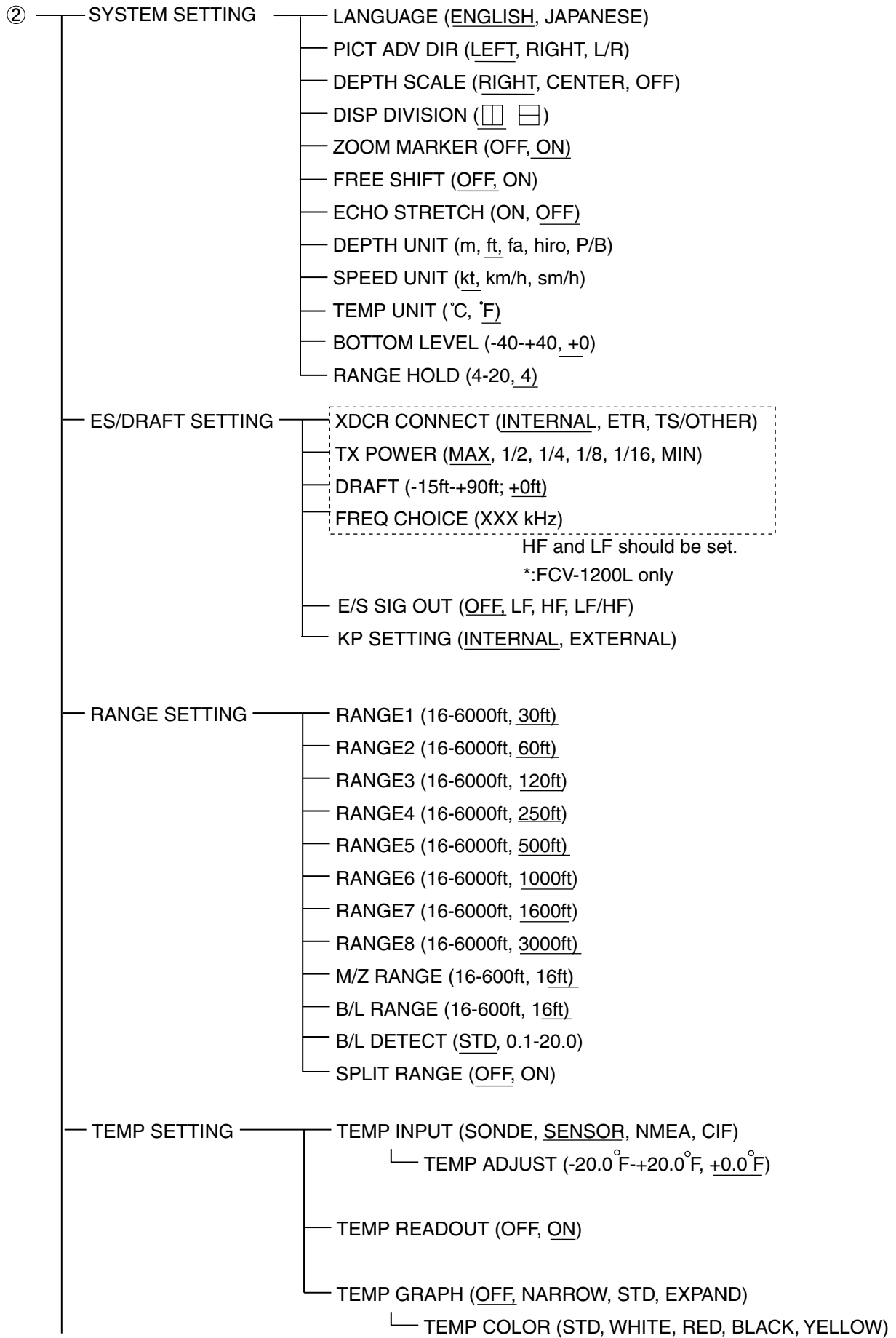

(Continued on the next page)

(Continued from the previous page)

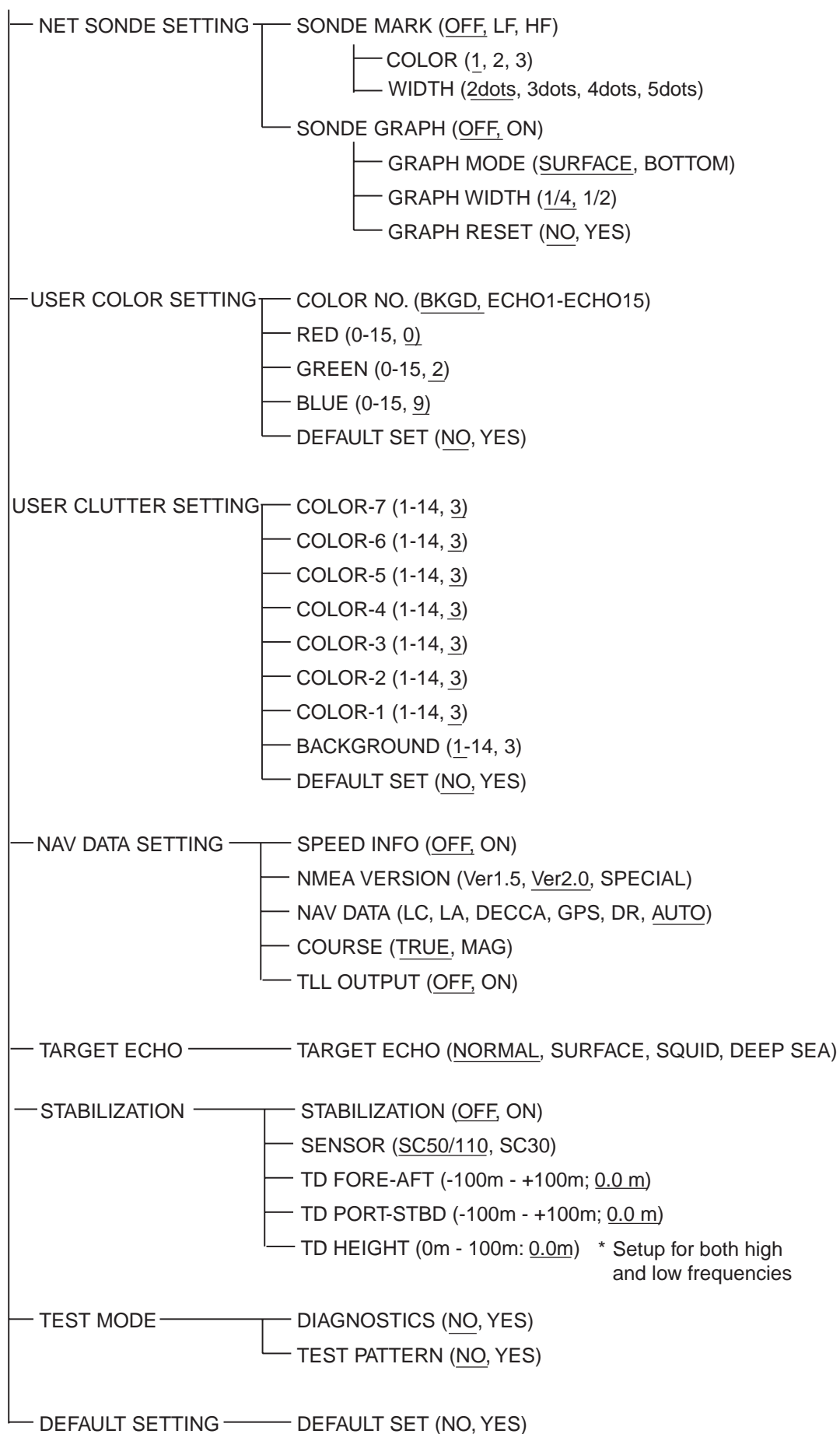

# APPENDIX 2 SCREEN DIVISION

---

The screen divisions are arranged as below through the SCREEN LAYOUT on the USER-1/2 menu.

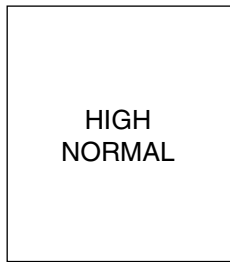
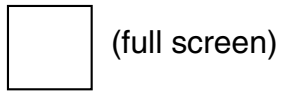

[HF]: Normal

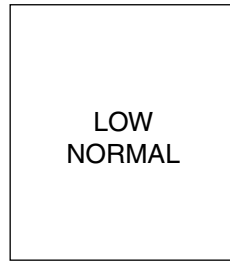

[LF]: Normal

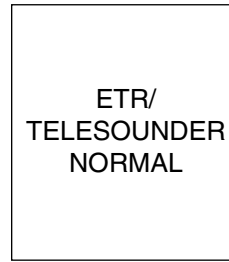

\*[Ex]: Normal

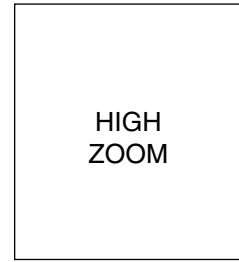

[HF]: Zoom

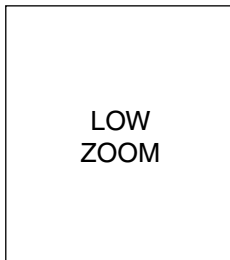

[LF]: Zoom



\*[Ex]: Zoom

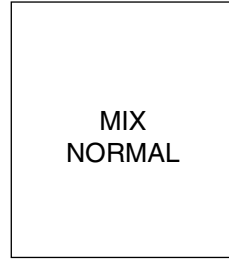

[Mix]: Normal

\*: For FCV-1200L with EXIF assy. (option). Select INTERNAL at HF/LF XDCR CONNECT on ES/DRAFT SETTING menu.

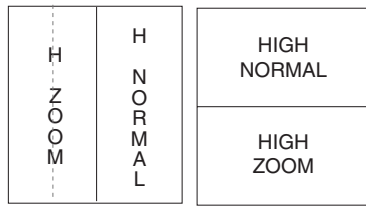
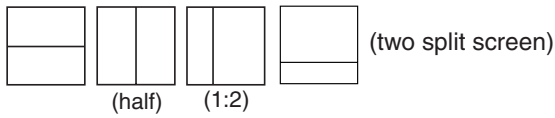

[HF]: Zm/Nor

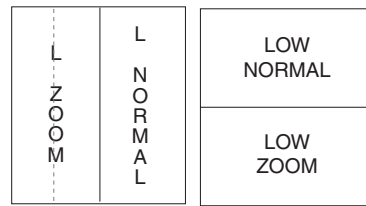

[LF]: Zm/Nor

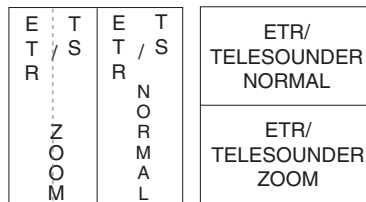

\*[Ex]: Zm/Nor

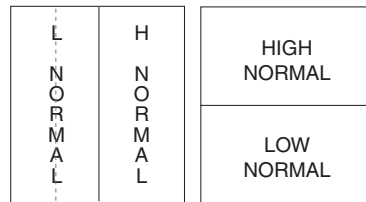

[LF]+[HF]

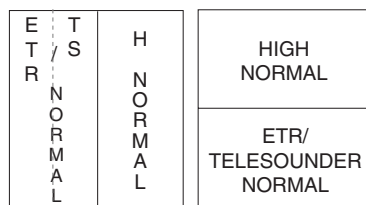

\*[Ex]+[HF]

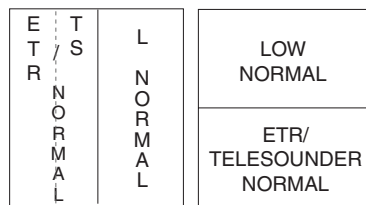

\*[Ex]+[LF]

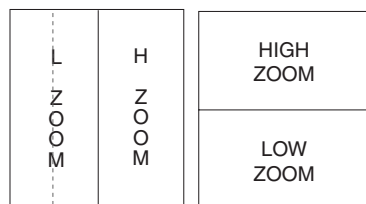

[LF]:Zm+[HF]:Zm

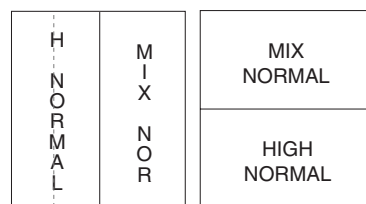

[HF]+[Mix]

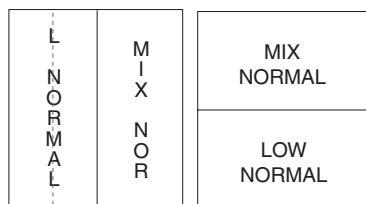

[LF]+[Mix]

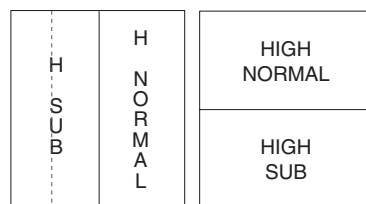

[H]sub+[HF]

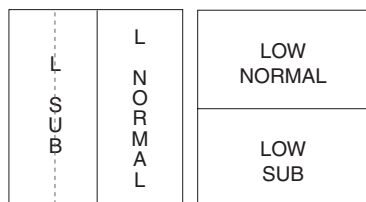

[L]sub+[LF]

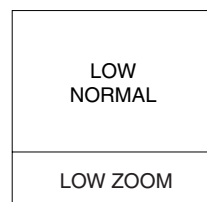

[LF]:Zm

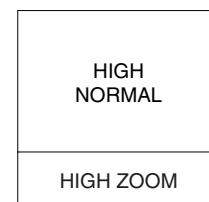

[HF]:Zm

The dashed line shows position of dividing line for vertical (1:2) split screen.

\*: For FCV-1200L with EXIF assy. (option). Select INTERNAL at HF/LF XDCR CONNECT on ES/DRAFT SETTING menu.

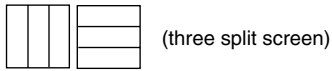

L	H	H	HIGH NORMAL
N	Z	N	HIGH ZOOM
O	O	O	LOW NORMAL
R	M	R	
M		M	
A		A	
L		L	

[LF]+[HF]: Zm/Nor

L	L	H	HIGH NORMAL
Z	N	N	LOW NORMAL
O	O	O	LOW ZOOM
R	M	R	
M		M	
A		A	
L		L	

[LF]: Zm/Nor+[HF]

E	H	H	HIGH NORMAL
T	Z	N	HIGH ZOOM
/	O	O	ETR/ TELESOUNDER NORMAL
S	M	R	
R		M	
N		N	
O		O	
R		R	
M		M	
A		A	

\*[Ex]+[HF]: Zm/Nor

E	L	L	LOW NORMAL
T	Z	N	LOW ZOOM
/	O	O	ETR/ TELESOUNDER NORMAL
S	M	R	
R		M	
N		N	
O		O	
R		R	
M		M	
A		A	

\*[Ex]+[LF]: Zm/Nor

E	E	H	HIGH NORMAL
T	T	N	ETR/ TELESOUNDER NORMAL
/	/	O	ETR/ TELESOUNDER ZOOM
S	S	R	
R	R	M	
N	N	N	
O	O	O	
R	R	R	
M	M	M	
A	A	A	

\*[EX]:Zm/Nor+[HF]

E	E	L	LOW NORMAL
T	T	N	ETR/ TELESOUNDER NORMAL
/	/	O	ETR/ TELESOUNDER ZOOM
S	S	R	
R	R	M	
N	N	N	
O	O	O	
R	R	R	
M	M	M	
A	A	A	

\*[EX]:Zm/Nor+[LF]

E	L	H	HIGH NORMAL
T	N	N	LOW NORMAL
/	O	O	ETR/ TELESOUNDER NORMAL
S	M	R	
R		M	
N		N	
O		O	
R		R	
M		M	
A		A	

\*[Ex]+[LF]+[HF]

L	H	M	MIX NORMAL
N	N	N	HIGH NORMAL
O	O	O	LOW NORMAL
R	M	R	
M		M	
A		A	
L		L	

[LF]+[HF]+[Mix]

L	H	H	HIGH NORMAL
N	S	N	HIGH SUB
O	O	O	LOW NORMAL
R	M	R	
M		M	
A		A	
L		L	

[LF]+[H]sub+[HF]

L	L	H	HIGH NORMAL
S	N	N	LOW NORMAL
O	O	O	LOW SUB
R	M	R	
M		M	
A		A	
L		L	

[L]sub+[LF]+[HF]

\*: For FCV-1200L with EXIF assy. (option). Select INTERNAL at HF/LF XDCR CONNECT on ES/DRAFT SETTING menu.

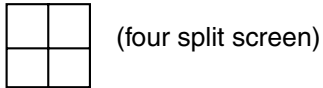

LOW NOR	HIGH NOR
LOW ZOOM	HIGH ZOOM

[LF]: Zm/Nor+[HF]: Zm/Nor



# APPENDIX 3 DISPLAY DIVISION

The display is arranged as shown below through DISP DIVISION on the SYSTEM SETTING menu.

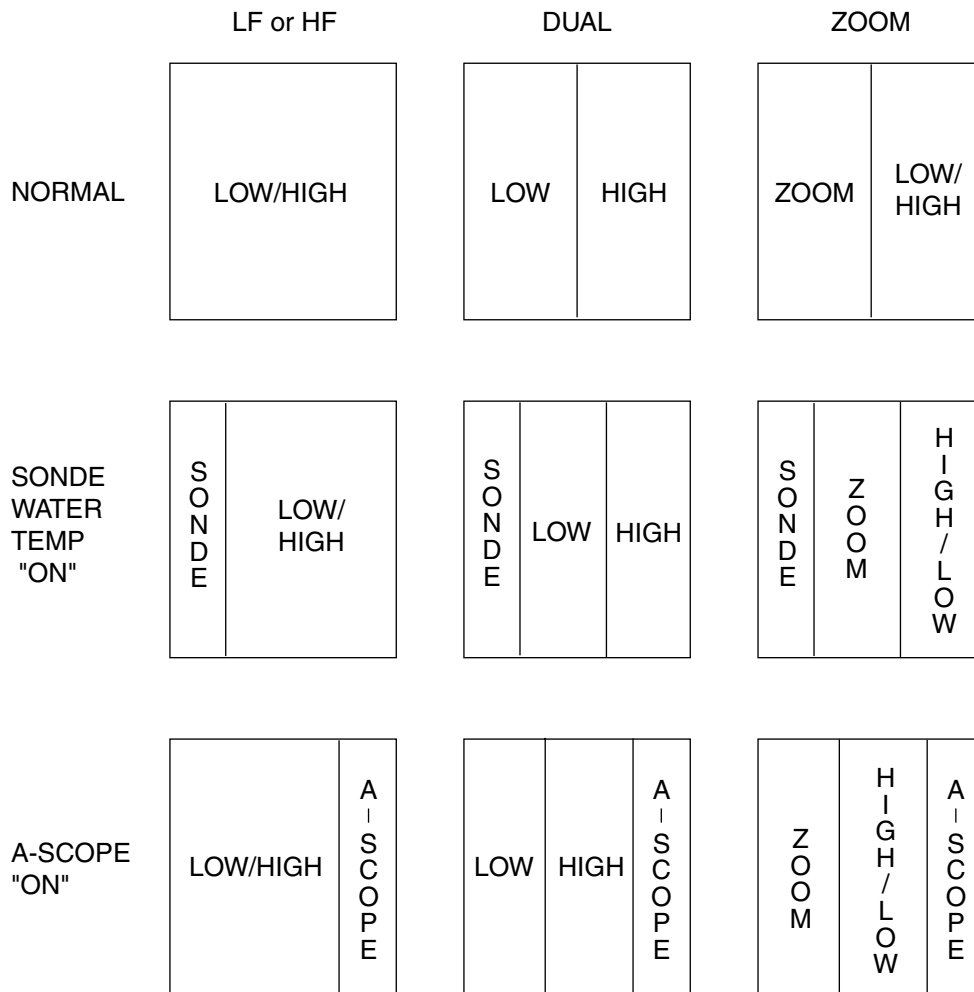
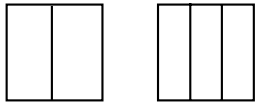

The width of the sonde temperature display may be set to 1/4 or 1/2 the screen size. Selection is made with SONDE GRAPH in the NET SONDE SETTING menu. When Sonde temperature display is set to 1/2, and the A-scope is turned on, the width of the sonde temperature display becomes 1/4 automatically.

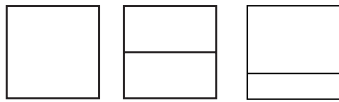

	LF or HF	DUAL	ZOOM	ZOOM
NORMAL	LOW/HIGH	HIGH LOW	LOW/HIGH ZOOM	LOW/HIGH NORMAL ZOOM
SONDE WATER TEMP "ON"	SONDE LOW/ HIGH	SONDE HIGH LOW	SONDE LOW/ HIGH ZOOM	
A-SCOPE "ON"	LOW/ HIGH A   S   C   O   P   E	HIGH LOW A   S   C   O   P   E	LOW/ HIGH ZOOM A   S   C   O   P   E	

The width of the sonde temperature display may be set to 1/4 or 1/2 the screen size. Selection is made with SONDE GRAPH in the NET SONDE SETTING menu. When Sonde temperature display is set to 1/2, and the A-scope is turned on, the width of the sonde temperature display becomes 1/4 automatically.

# FURUNO

## SPECIFICATIONS OF THE COLOR LCD VIDEO SOUNDER FCV-1200L/FCV-1200LM

### 1. ECHO SOUNDER (FCV-1200L ONLY)

- (1) TX Frequency 15/28/38/45/50/68/88/107/150/200/400 kHz, select 2 channels  
400 kHz requires optional transmit board
- (2) Output Power 1, 2 or 3 kW<sub>rms</sub>
- (3) TX Rate 5 to 1000 pulse/min (20 to 1000 m range, normal mode)  
Max. 2400 pulse/min (5 m range, surface mode)
- (4) Pulselength 0.2 to 5.0 msec

### 2. DISPLAY UNIT

- (1) Display Mode 10.4 inch TFT color LCD, VGA: 640 x 480 pixels, Portrait/Landscape
- (2) Echo Color 8 or 16 colors according to echo intensity.
- (3) Background Color Selectable among 5 colors.
- (4) Display Mode Single mode (high/low frequency), Dual-frequency, Zoom, Mix, A-scope
- (5) Zoom Display Marker zoom, Bottom zoom, Bottom-lock expansion
- (6) Range Shift Range: 5-2000 m, Shift: 0-2000 m, Expansion range: 5-200 m
- (7) Display Advance Speed 7 steps (Lines/TX: Freeze, 1/16, 1/8, 1/4, 1/2, 1/1, 2/1, 3/1, 4/1)
- (8) Alarm Fish alarm, Water temperature alarm, Bottom alarm
- (9) Noise Limiter Frequency adjustable range:  $\pm 10\%$  (-4.5 to +10% for 68/200 kHz)
- (10) Other Features Automatic bottom tracking, Clutter rejector,  
Water temperature graph (optional sensor required)

### 3. INTERFACE

- (1) Data Format IEC 61162-1, NMEA0183 Ver.1.5/2.0
- (2) Input Data GGA, GLC, GLL, GTD, MTW, RMA, RMB, RMC, VTG, att, hve  
Any talker is available
- (3) Output Data SDDBS, SDDBT, SDDPT, SDTLL, YCMTW\*, VRM  
\*: Optional sensor required
- (4) Output for Monitor RGB: VGA signal, optional interface IF-8000 required

### 4. POWER SUPPLY

- (1) Voltage and Current 12-24 VDC: 10.0-5.0 A
- (2) Power Consumption 120 VA or less
- (3) Rectifier 100/110/115/200/220/230 VAC available (option)

# FURUNO

## 5. ENVIRONMENTAL CONDITION

- (1) Temperature                      -15 °C to +55 °C
- (2) Relative Humidity                Less than 95% (at 40°C)
- (3) Water Resistance                Display Unit and Control Unit: IEC IPX5  
   Processor Unit: IEC IPX2

## 6. COATING COLOR

- (1) Processor Unit                    2.5GY5/1.5
- (2) Display Unit and Control Unit  
   Panel: N3.0 Sleektone No.535, Chassis: 2.5GY5/1.5

# INDEX

---

## **A**

advance speed ..... 1-19  
aerated water ..... 4-6  
A-scope display ..... 1-21

## **B**

background color ..... 2-3  
basic range ..... 1-11  
B/L DETECT ..... 3-8  
BOTTOM ALARM ..... 2-7  
BOTTOM LOCK ..... 1-6  
Bottom nature ..... 4-4  
Bottom profile ..... 4-3  
BOTTOM ZOOM ..... 1-6  
BRILL key ..... 1-3  
BTM-FISH ALARM ..... 2-7

## **C**

clutter ..... 1-15  
Current rip ..... 4-5

## **D**

DEPTH UNIT ..... 3-3  
discrimination ..... 1-6  
DISPLAY DATA ..... 2-5  
DRAFT ..... 3-5  
dual ..... 1-5

## **F**

False image ..... 4-6  
FISH ALARM ..... 2-7  
Fish quantity ..... 4-4  
Fish school size ..... 4-4

## **G**

GAIN control ..... 1-13

## **H**

HUE ..... 2-3

## **I**

interference ..... 1-22

## **L**

language ..... 3-2

## **M**

marker Line ..... 1-14  
MARKER ZOOM ..... 1-6  
MARKER/TLL key ..... 1-14  
mix ..... 1-9  
MODE switch ..... 1-4

## **N**

navigation data ..... 3-16  
NMEA ..... 3-16

## **P**

Panel test ..... 5-5  
Plankton ..... 4-5

## **R**

Range hold ..... 3-4  
RANGE switch ..... 1-11

## **S**

screen division ..... 2-12  
shift ..... 1-12  
signal level ..... 1-18  
single picture ..... 1-4  
smoothing ..... 2-6  
SPEED UNIT ..... 3-3  
STABILIZATION ..... 3-18  
sub gain ..... 2-13  
Surface noise ..... 4-6

## **T**

TEMP ALARM ..... 2-7  
TEMP UNIT ..... 3-3  
temperature graph ..... 3-9  
TVG ..... 1-16  
TX power ..... 3-5

*U*

USER-1,2 ..... 1-9

*V*

VRM ..... 1-13

*W*

white line ..... 2-3

WHITE MARKER ..... 2-4