

NAVTEX system operation

The world is divided into 16 areas (called Navareas) as shown at right. Each Navarea has multiple NAVTEX stations and each NAVTEX station has an identification code, from "A" to "Z."
The service range of a NAVTEX station is typically 200-400 nautical miles depending on the terrain and station transmit power. A NAVTEX station normally broadcasts every four hours.
There are two channels including international channel, 518 kHz, and local channels, 490 and 4209.5 kHz. International channels broadcast messages in English. On local channels, 490 kHz, is available in the UK, France, etc., using their own languages. 4209.5 kHz is allocated for NAVTEX broadcasts in tropical areas - not widely used at the moment.

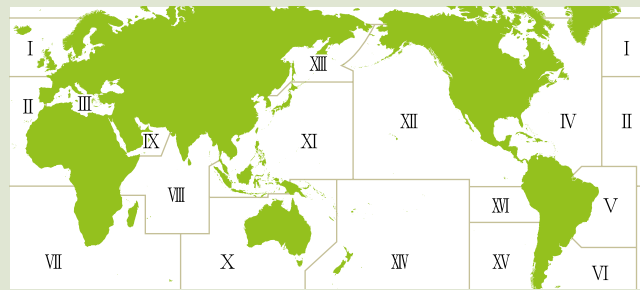

FURUNO®

SPECIFICATIONS

NAVTEX RECEIVER	
Receiving Frequency	518 kHz and 490 or 4209.5 kHz
Mode of Reception	F1B
Sensitivity	2 μV e.m.f. (50 ohms), 4% error rate
Input Protection	Withstands 30 Vrms for 15 min or more (w/ preamp unit)
Spurious Emission	1 nW or less
Message Category	A : Navigation warning B : Meteorological warning C : Ice report D : Search and rescue information/ piracy and armed robbery E : Meteorological forecast F : Pilot message G : Decca message H : Loran-C message I : Omega message J : Differential omega message K : Other electronic navigational aid and system message L : Navigational warning (additional) M to Y : Reserved - presently not used V : Notice to Fishermen (US only) Z : QRU (no message on hand)
DISPLAY	
Screen Size	5" monochrome LCD, 76 x 100 mm
Resolution	240(H) x 320(V)
Display Modes	Message, List, NAV Data
ID Storage	200 x 2 channels
Message Storage	200 messages x 2 channels (100,000 characters x 2 channels)
PRINTER SECTION (for NX-700A)	
Printing System	Line thermal head printing system
Printing Paper	Thermal paper (58 mm x 30 m)
Printing Width	48 mm
Character Format	24 x 12 dot
Dot Pitch	8 dots/mm
Number of Characters	32 characters/line
Print Speed	20 mm/sec.
ANTENNA UNIT	
Antenna Type	NX-7H: H-field antenna with preamp
Output Impedance	50 ohms
Power Supply	+8 V to +9 V (thru co-ax cable)

INTERFACE	
Input	IEC61162-2 ACK, GGA, GLL, GNS, NNM, NRQ, RMC, VBW, VHW, VTG, ZDA IEC61162-2 message data for INS, PC ALR, NRX RS-232C for printer(NX-700B only) Contact closure signal (max. 0.5A, 50V) for SAR alert
Output	
Alarm	
POWER SUPPLY	
NX-700A:	12-24 VDC, 1.5-0.8 A
NX-700B:	12-24 VDC, 0.7-0.4 A
ENVIRONMENT (fully complied with IEC 60945 3rd/4th ed.)	
Temperature	
Antenna Unit:	-25°C to +70°C (-13°F to +158°F)
Receiver, Display Unit:	-15°C to +55°C (5°F to +131°F)
Waterproofing	
Antenna Unit:	IP66
Receiver Unit:	IP20
Display Unit:	
NX-700A:	IP20
NX-700B:	IP25 (front panel)

EQUIPMENT LIST

- Standard**
- | | |
|--|--------|
| 1. Receiver Unit NX-7001 | 1 unit |
| 2. Antenna Unit NX-7H | 1 unit |
| 3. Display Unit with Bracket (Specify when ordering) | 1 unit |
| NX-700A: Display with Printer, NX-700B: Display only | |
| 4. Installation Materials and Spare Parts | 1 set |
- Option**
- | | |
|--|---|
| 1. Antenna Mounting Base
Pipe mount: CP20-01111
Deck mount: 13-QA330
Handrail mount 13-RC5160
Offset bracket: 13-QA310 | 4. Flush Mount Kit for Display Unit
for NX-700A: OP08-19
for NX-700B: OP08-20 |
| 2. Cable for Antenna
3D2V, 10/20/30/40/50 m;
RG10U, 30/40/50 m | 5. Power Supply Unit PR-240-CE |
| 3. Cable for Display Unit
D-Sub 25P to D-Sub 25P, 5/10/15 m | 6. Thermal Paper for NX-700A |

INTERCONNECTION DIAGRAM

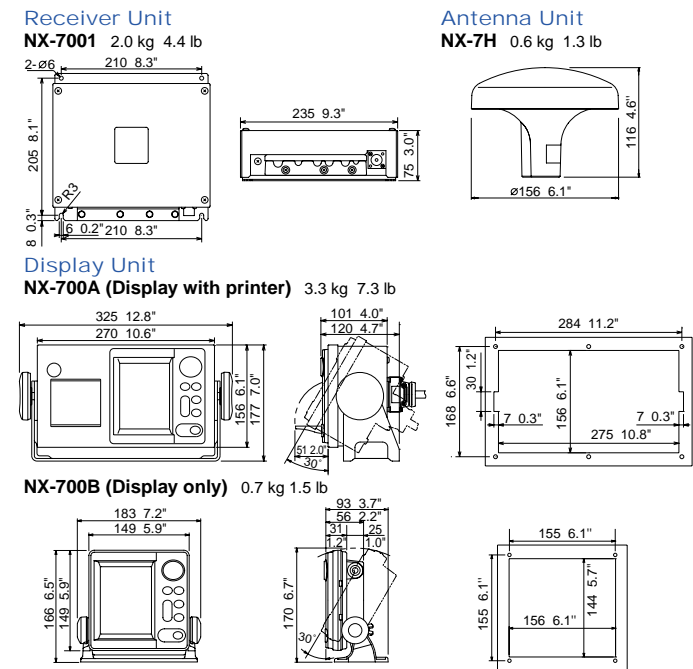
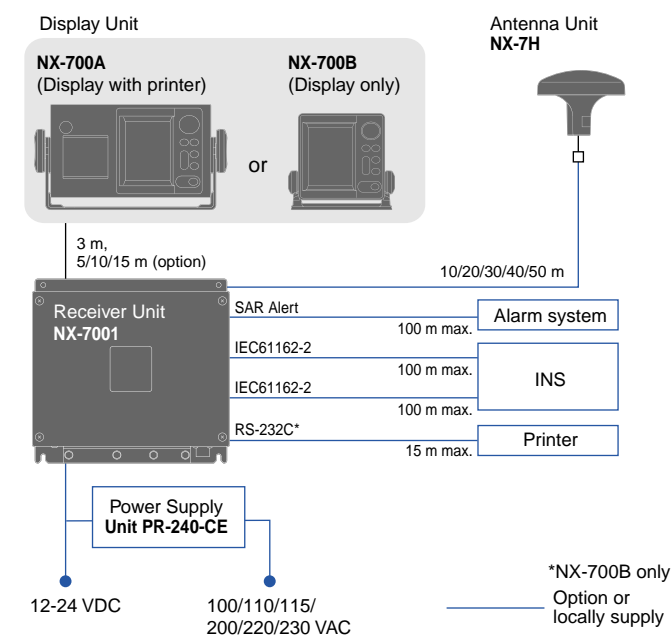

NAVTEX

Dual-channel NAVTEX Receiver

Message display with printer

NX-700A

Message display unit

NX-700B



TRADE MARK REGISTERED MARCA REGISTRADA
SPECIFICATIONS SUBJECT TO CHANGE WITHOUT NOTICE

FURUNO U.S.A., INC. Camas, Washington, U.S.A. Phone: +1 360-834-9300 Fax: +1 360-834-9400	FURUNO ESPAÑA S.A. Madrid, Spain Phone: +34 91-725-90-88 Fax: +34 91-725-98-97	FURUNO SVERIGE AB Västra Frölunda, Sweden Phone: +46 31-7098940 Fax: +46 31-497093	FURUNO DEUTSCHLAND GmbH Rellingen, Germany Phone: +49 4101 838 0 Fax: +49 4101 838 111
FURUNO (UK) LIMITED Denmead, Hampshire, U.K. Phone: +44 2392-230303 Fax: +44 2392-230101	FURUNO DANMARK AS Hvidovre, Denmark Phone: +45 36 77 45 00 Fax: +45 36 77 45 01	FURUNO FINLAND OY Espoo, Finland Phone: +358 9 4355 670 Fax: +358 9 4355 6710	FURUNO EURUS LLC Petersburg, Russia Phone: +7 812 767 15 92 Fax: +7 812 766 55 52
FURUNO FRANCE S.A. Bordeaux-Mérignac, France Phone: +33 5 56 13 48 00 Fax: +33 5 56 13 48 01	FURUNO NORGE A/S Ålesund, Norway Phone: +47 70 102950 Fax: +47 70 127021	FURUNO POLSKA Sp. z o.o. Gdynia, Poland Phone: +48 58 669 02 20 Fax: +48 58 669 02 21	PRINTED WITH SOYINK 0508XU Printed in Japan



The future today with FURUNO's electronics technology.
FURUNO ELECTRIC CO., LTD.
9-52 Ashihara-cho, Nishinomiya City, Japan Phone: +81 (0)798 65-2111
Fax: +81 (0)798 65-4200, 66-4622 URL: www.furuno.co.jp

Catalogue No. FX-619a

TRADE MARK REGISTERED
MARCA REGISTRADA

NAVTEX

Dual-channel NAVTEX Receiver

Enhances the navigation efficiency and safety by watching NAVTEX messages broadcasted on both international and local channels

FURUNO NX-700 is a dual-channel NAVTEX receiver for SOLAS ships complying with the new NAVTEX performance standard MSC.148(77) which is implemented on and after 1 July 2005.

The NX-700 can receive two channels simultaneously. One is set for 518 kHz to receive international NAVTEX messages and another is selectable from 490 or 4209.5 kHz for domestic or local NAVTEX messages. These messages include a variety of safety information such as Navigational Warnings, Meteorological Warnings, Search and Rescue (SAR) information and other information for ships sailing within the reach of each service station's coverage. The broadcast station can be selected automatically according to own ship position when the NX-700 is connected with a GPS navigator.

Every incoming message is stored in non-volatile memory and is displayed on the clear 5" silver bright LCD. Three different font sizes are available and one of them can be selected on menu.

The NX-700A consists of a receiver, display with printer and antenna units. The NX-700B has a low profile, stylish display without a printer, receiver and antenna units. The compact umbrella type antenna requires no grounding because it is H-field antenna. In addition, the antenna incorporates a high-performance preamp within the compact body, which gives reliable and uninterrupted reception without an extra whip antenna.



NX-700A (Display with printer)



NX-700B (Display only)

Antenna Unit

Receiver Unit

Dual-channel NAVTEX Receiver

NX-700A/B

- ▶ Fully meets new IMO resolution MSC.148(77) to be implemented on and after 1 July 2005 requiring:
 - Dual channel reception, 518 kHz and either 490 or 4209.5 kHz, simultaneously
 - Incorporates a printing device (NX-700A) or a dedicated display device with printer output (NX-700B)
 - 200 message of average length 500 characters can be stored in non-volatile memory
- ▶ Incorporates a preamp within a lightweight, compact antenna for reliable, uninterrupted reception
- ▶ Display messages on a clear 5" silver bright LCD
- ▶ Low power consumption
- ▶ NAV data display acts as NMEA repeater for GPS or instruments



Operators can print out important messages by pressing a dedicated "PRINT" button.

Message inbox

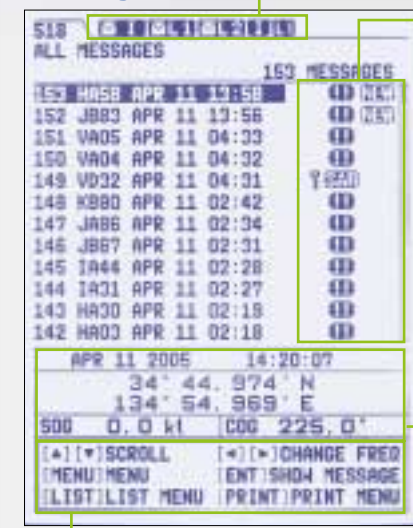

Status icons
Message icons

All received messages with a selected channel information are sorted by order of time in the message inbox. Operators can easily know the status of each message from the message ID and icons. When receiving SAR information, NX-700 notifies of the incoming messages by audible alarm. For quick viewing, operators can pick up messages they are interested in and display them by using the sort function.

Guide for key controls

NavData window

Essential navigational data is clearly displayed at the bottom of display when connected with a positioning equipment.

Icons

Status icon	
	Shows that an International frequency (518 kHz) message has not been read.
	Shows that a Local frequency message has not been read. L1: 490 kHz, L2: 4209.5 kHz
	Displayed while the NAVTEX is receiving a message. L1: International frequency (518 kHz), L2: 490 kHz, L2: 4209.5 kHz
	Displayed when the battery voltage is low.
	Print error (no paper, not connected to the printer, etc.)
	While printing.
Message icon	
	Displayed when message has not been read yet.
	Displayed when message type D (SAR) is received.
	Displayed when message type A, B or L (Warning) is received.
	Protected message

Message display

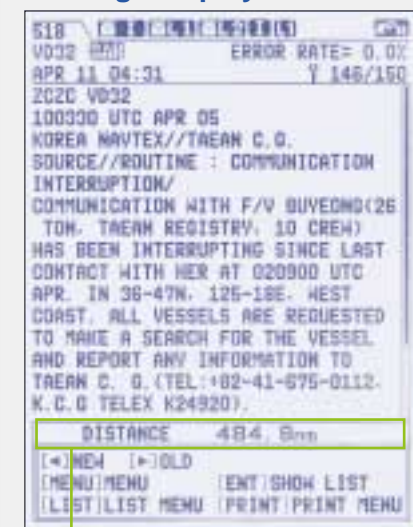

Message format

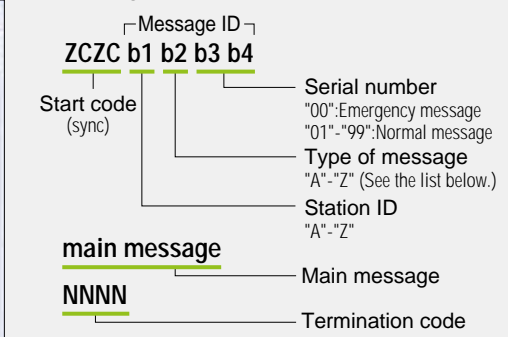

Fonts

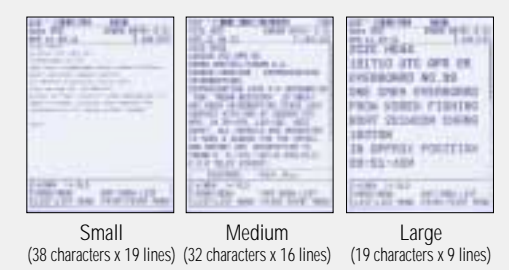

Three font sizes are available for convenience of the operation.

Type of message (category)

A	Navigational warning	I	OMEGA message
B	Meteorological warning	J	Differential OMEGA message
C	Ice report	K	Other electronic navigational aid system message
D	Search and rescue information/ piracy and armed robbery	L	Navigational warning (additional)
E	Meteorological forecast	M to U	Reserve-presently not used
F	Pilot message	V	Notice to Fishermen (U. S. only)
G	DECCA message	W to Y	Reserve-presently not used
H	LORAN-C message	Z	QRU (no message on hand)

Distance window

Shows distance from own ship to a position of event, which is mentioned in message. This enables swift understanding of whether the position is nearby own ship or not.